

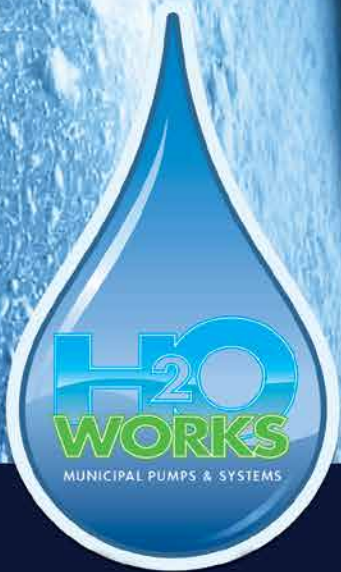

H₂O WORKS

Municipal Pumps & Systems

*Unparalleled solutions
In Clean Water Pumping*



The Pump People[®]
Patterson

A Gorman-Rupp Company



Proven Quality and Reliability

Patterson's H2O Works™ Municipal Pumps & Systems provide the flow power for clean water applications worldwide. This pump line includes Horizontal Split Case (HSC), Two-State (HSC) DMD, End Suction, Vertical In-Line, Vertical Turbine, and Axial & Mixed Flow.

Daily performing unparalleled, reliable service in these clean water applications throughout North and South America, Europe, the Middle East, the Far East, Africa, Asia and Australia.

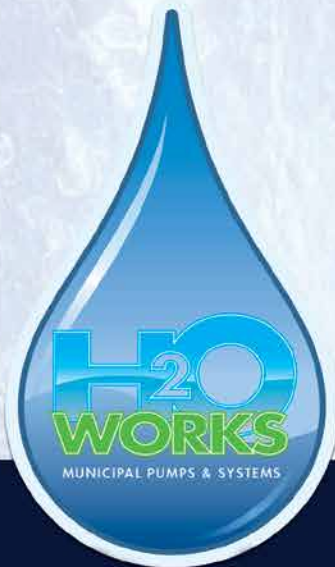

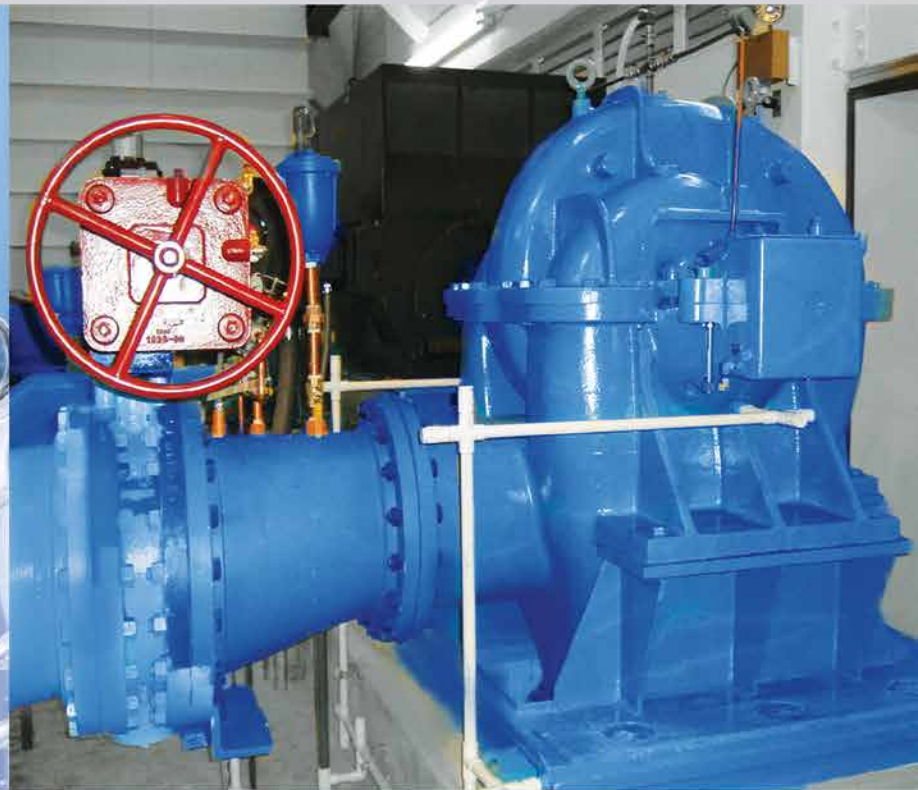

With more than a century of engineering expertise standing behind every application, these high performing pumps and systems provide potable water to cities and homes from reservoirs, rivers and wells. They meet the irrigation demands of large-scale agricultural sites. And they assist industry with daily processing needs.

Performing all types of heavy duty pumping chores, including marine, primary metals, utilities and process applications—even quench, stripper bottom, reboiler and cooling processes—these pumps move all types of clean water, including:

- Potable Water
- Raw Water
- Salt Water
- Cooling Media
- Process Fluids

The Pump People®

Horizontal Split Case Pumps

For most efficient movement of clear water or low viscosity clear liquids at moderate heads.

Patterson Horizontal Split Case Pumps are engineered to move clear water and low viscosity clear liquids at moderate heads more efficiently and economically than any other type of pump. The HSC pump leads the way with flow power and regulation technology that manages temperature, pressure and flow for comfort and efficiency.

Precision balancing of all factors in the design of Horizontal Split Case Pumps provides efficient operation along with mechanical dependability and low cost maintenance. Their simplicity of design ensures long, efficient unit life and minimum power consumption.

All fabricated parts are standardized and accurately machined for true alignment, increasing overall durability. Impellers are statically and dynamically balanced and constructed with double inlets, practically eliminating end thrust and resulting in high operating efficiency.

These split case pumps meet Hydraulic Institute Standards in capacities from 50 gpm to more than 100,000 gpm, with single stage heads to 550 ft and two-stage heads

to 1,150 ft. The medium and high heads are offered for water and industrial/commercial duties, including city water booster service, brine and hot water circulation, hot well and make up water service, low viscosity liquid handling and power plant condenser circulation.

Available with up to 48 in. discharge outlets, the Patterson pumps can be configured to custom designs for individual needs.



Zero Flush Technology. Patterson pumps are now available with a sealing arrangement that requires no water.

This new technology features EnviroSeal's Spiratrac throat bushing and Chesterton's model 442** Split Mechanical Seal.*

*Spiratrac is a trademark of EnviroSeal Engineering Products Ltd.

**442 is a trademark of A.W. Chesterton Company.

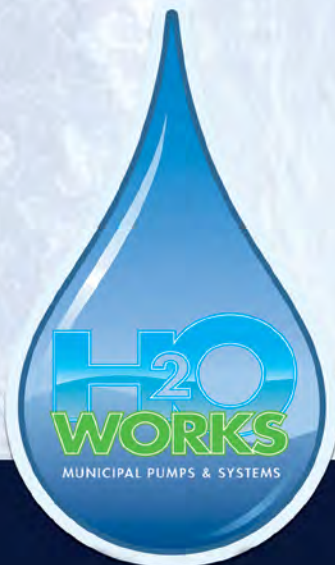

Shaft sleeves locked against rotation by impeller key.

Dynamically balanced impeller.

Casing rings provided to protect casing from wear.

Replaceable packing box bushing provided to protect casing from packing wear.

Deflectors provided to prevent product from entering bearing housings.

Packed pumps are standard with split glands and lantern ring. Optional mechanical seal is available.

Integrally cast packing boxes.

Chesterton 442. Integrally cast bearing supports (12-in. discharge and below).

Predrilled and tapped packing box drip pockets for removal of packing box leakage.

Machine mounting surfaces.

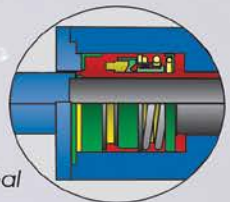
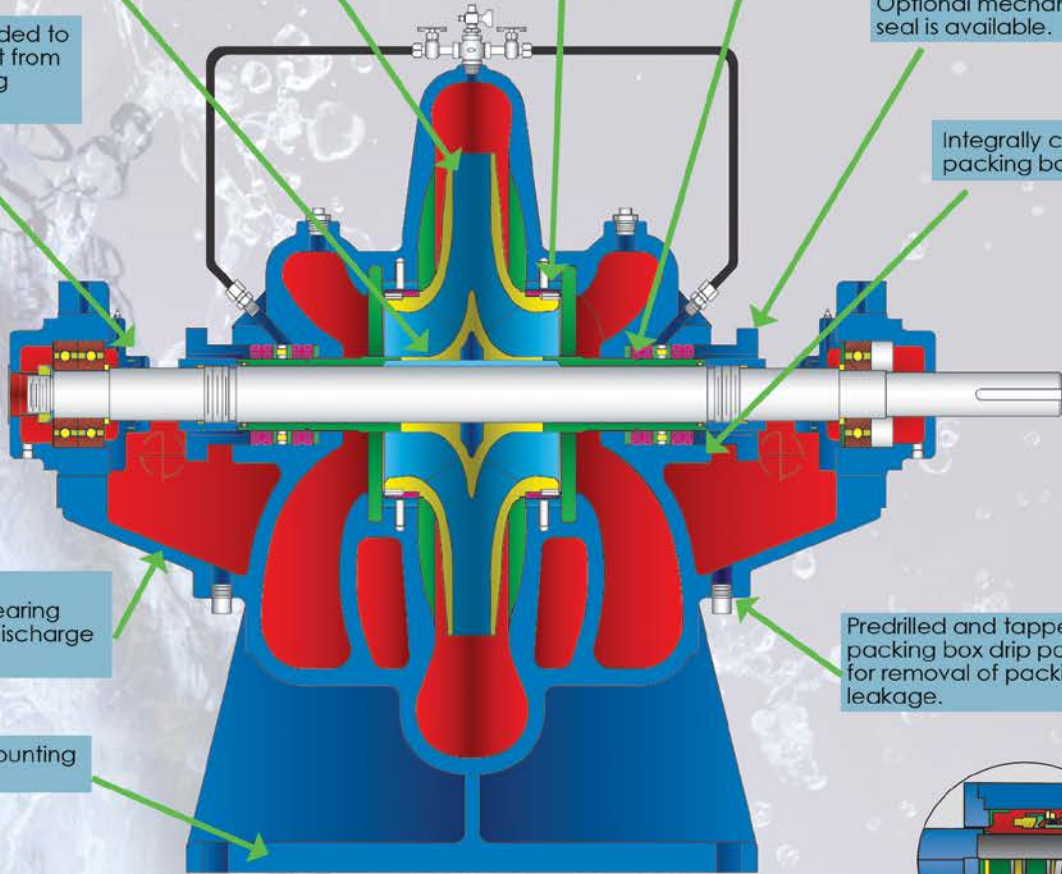

Patterson PRG Mechanical Seal



Chesterton 442.



SpiralTrac.

The Pump People®

Vertical Split Case Pumps.

Patterson's Horizontal Split Case Pumps may also be vertically positioned and driven by an electric motor or diesel engine, which will operate the pump at the required speed.

Water or other liquid enters at the intake, and the rotating impellers discharge the liquid by centrifugal force into the casing, which surrounds the impellers. Pressure developed by the pump is the result of the velocity imparted by the impellers and not by any impact or replacement.

Wear rings protect the casing from wear. Ball or split sleeve bearings, located on both sides of the rotor, are enclosed in dust-proof cartridges. Twin stuffing boxes and double bearing construction ensure long packing life. Packed pumps are standard with split glands and a lantern ring. Replaceable packing box bushings protect the casing from packing wear. Optional mechanical seals are available. Bearing supports are integrally cast (12-in. discharge and below).

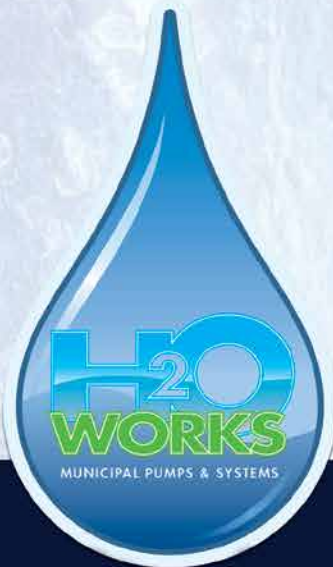

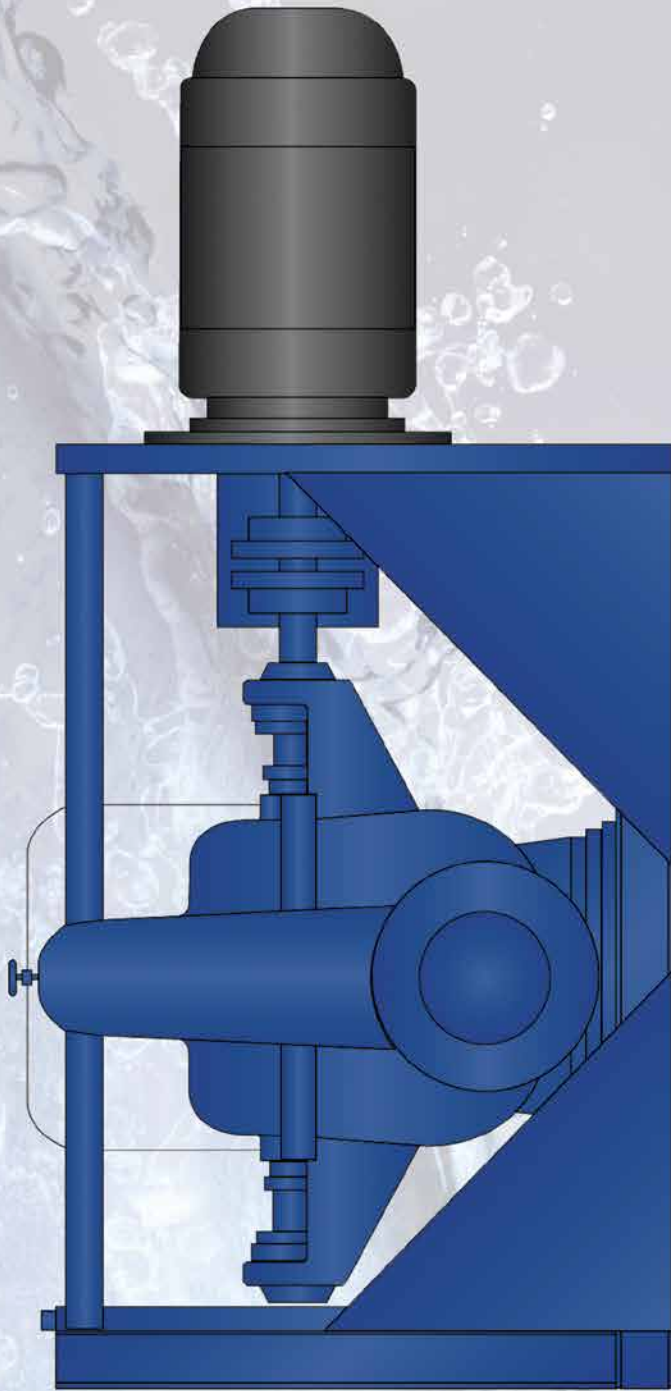

Vertical Split Case



Two-Stage DMD Centrifugal Pumps

The most economical pumping equipment available for rugged and reliable service.

H2O Works™ type DMD Two-Stage Pumps are engineered to produce as much head as two single-stage HSC pumps in series, but they are much more compact in size. These rugged units are highly efficient and engineered to assure long and reliable service.

Their single inlet construction permits a shorter span between bearings with half as many wearing rings to maintain. Packing boxes and bearing supports are integrally cast (except in the 10x10 DMD). An optional mechanical seal is available. Casing rings protect the casing from wear.

Sizes range from 2 in. to 10 in. discharge, with capacities to 3,500 gpm and heads to 1,150 ft. Typical applications include water resources and industrial service such as high-head water works, hydraulic elevators, oil refineries, mining operations, chemical plants, and as boiler feed pumps.

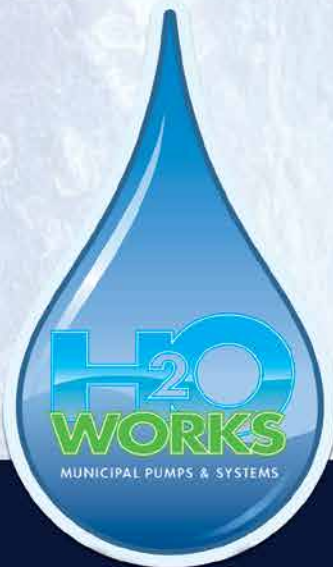

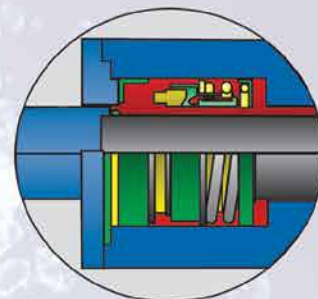
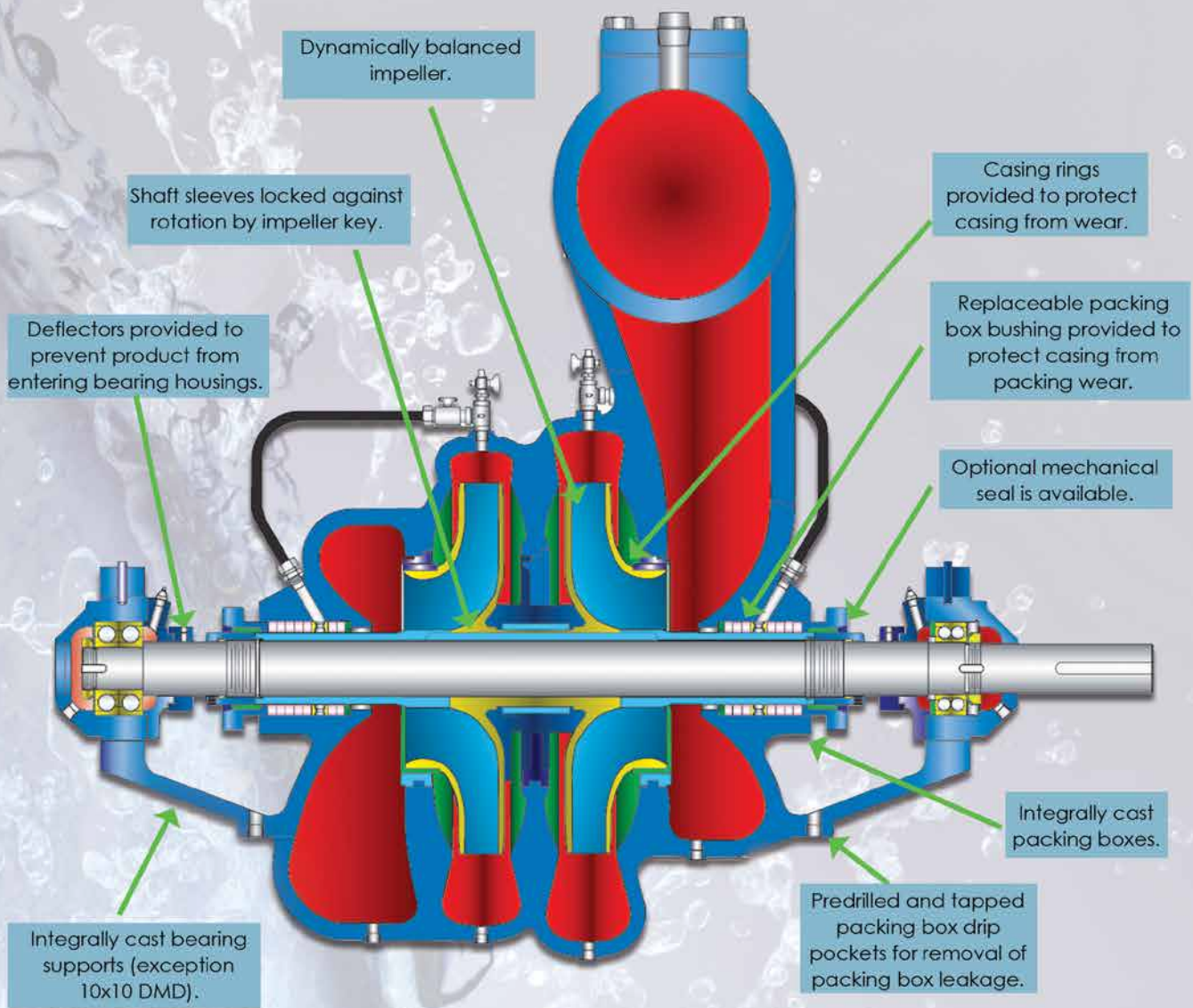

Optional Mechanical Seal

End Suction Pumps

Designed for ease in adapting to existing systems or being designed into new ones.

Patterson End Suction Pumps feature centerline suction and discharge—a high-efficiency design that minimizes energy consumption. They are engineered to last, with a precision cast, dynamically balanced impeller that minimizes vibration and maximizes bearing life.

End Suction Pumps are available in capacities to 2,500 gpm and heads to 400 ft tdh. Each pump is hydrostatically pressure-tested to 1-1/2 times shutoff before shipment.

A back pullout design allows removal of the rotating element without disturbing suction and discharge connections. Each pump is fitted with a shaft sleeve and a self-flushing mechanical seal.

Registered fits at the volute cover and volute maintain pump alignment.

Two end suction models are available—a frame mounted and a close-coupled unit. Close-coupled units can be either flanged or threaded.

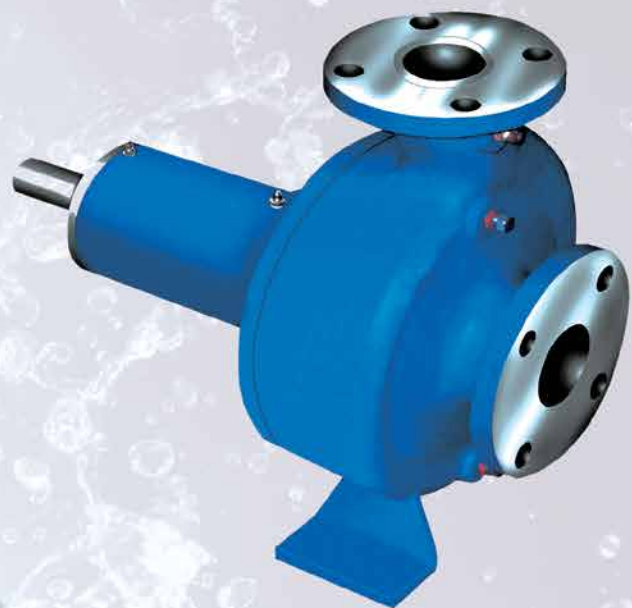

Close-coupled End Suction Pump.

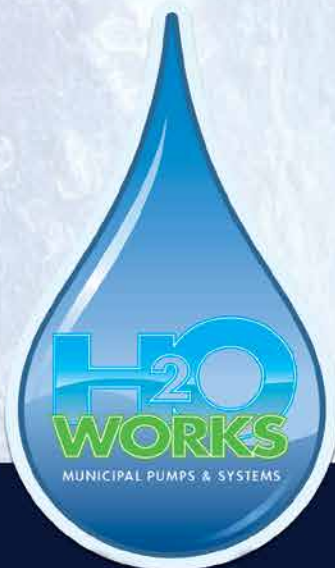

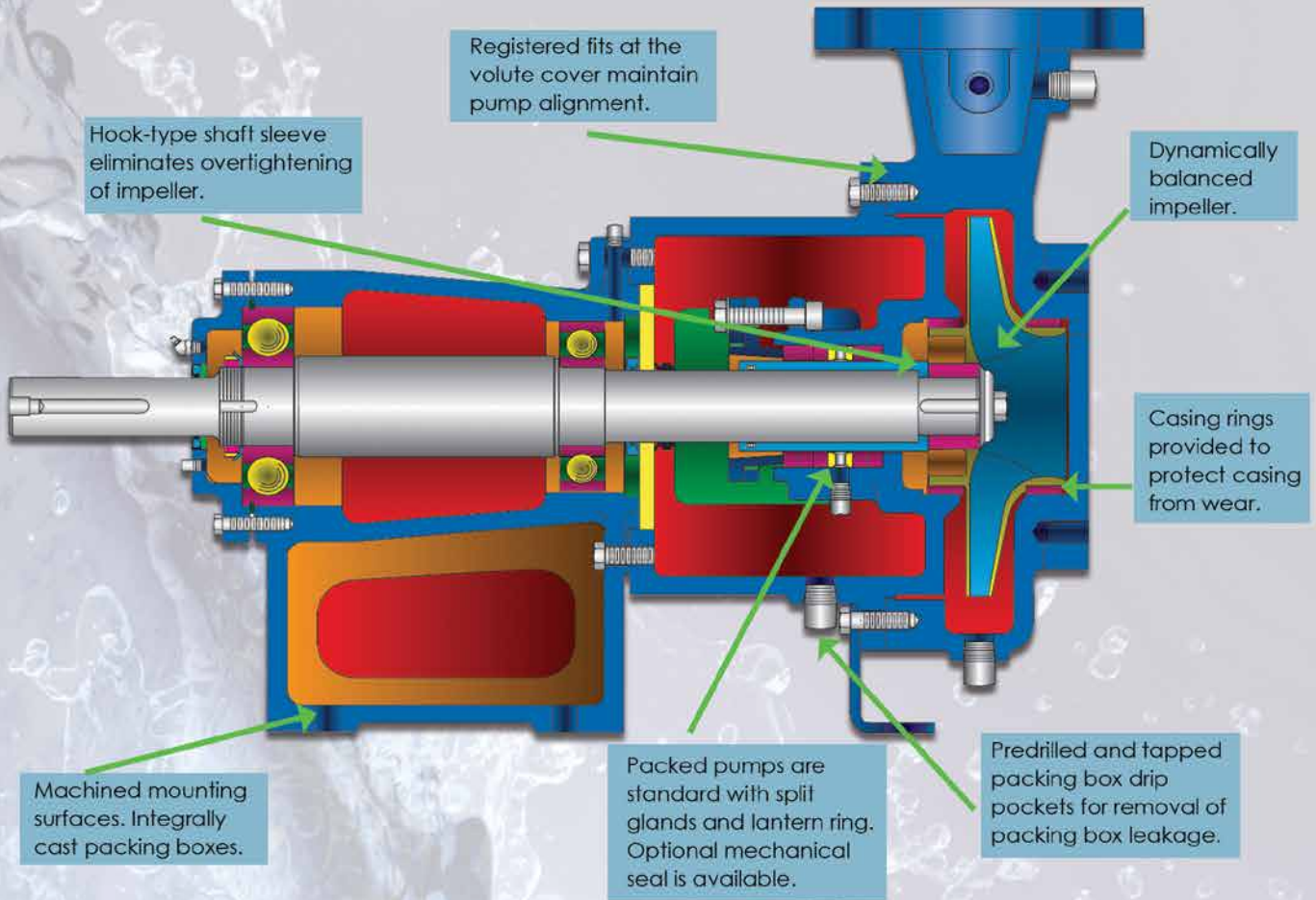

The Pump People®

Vertical In-Line Pumps

Compact, self-contained design makes them easily adaptable to existing or new systems.

Patterson's V.I.P. series of Vertical In-Line Pumps offer a simple, an economical and an efficient alternative to end suction and horizontal split case pumps in flows less than 2,500 gpm.

These in-line pumps, in particular, offer the full flexibility to serve all applications and overcome constraints, while minimizing energy consumption and lengthening service life.

The Vertical In-Line Pumps are easily and inexpensively installed, since they require no foundation or concrete pad. Only standard piping supports on either side of the pump are needed.

Vertical in-line suction and discharge flanges are on a common centerline, 180° apart, for easy installation into an existing pipeline.

The V.I.P. is available with either packing or a mechanical seal. When packing is utilized, a two-piece gland is provided for easy removal and packing installation.

The mechanically sealed pump can be converted to packing in the field. Competing in-line pumps offer mechanical seals on standard models, but do not provide a gland, and the mechanical seal is installed underneath the volute cover. This does not afford the user the flexibility of converting to packing if the mechanical seal fails. Nor, does the design allow for inspection of the mechanical seal without "tearing down" the pump.

The V.I.P.'s standard JP/JM motor format, designed for this service by NEMA and Hydraulic Institute, provides quality integral drive systems that assure the uniformity of tolerances, minimum shaft deflection and bearings properly sized for the job.

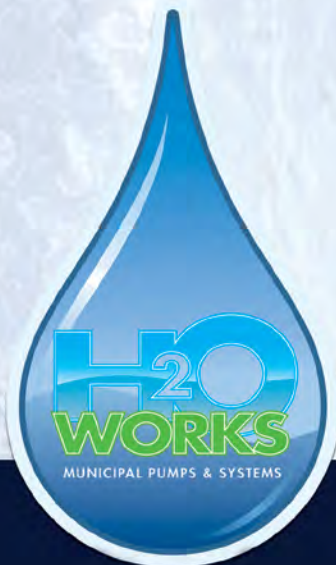

Packed pumps are standard with split glands and lantern ring. Optional mechanical seal is available.

Registered fits at the volute cover maintain pump alignment.

Casing rings provided to protect casing from wear.

Easy clean out. Debris can be removed without disassembling pump.

Predrilled and tapped packing box drip pockets for removal of packing box leakage.

Dynamically balanced impeller.

Integrally cast packing boxes.

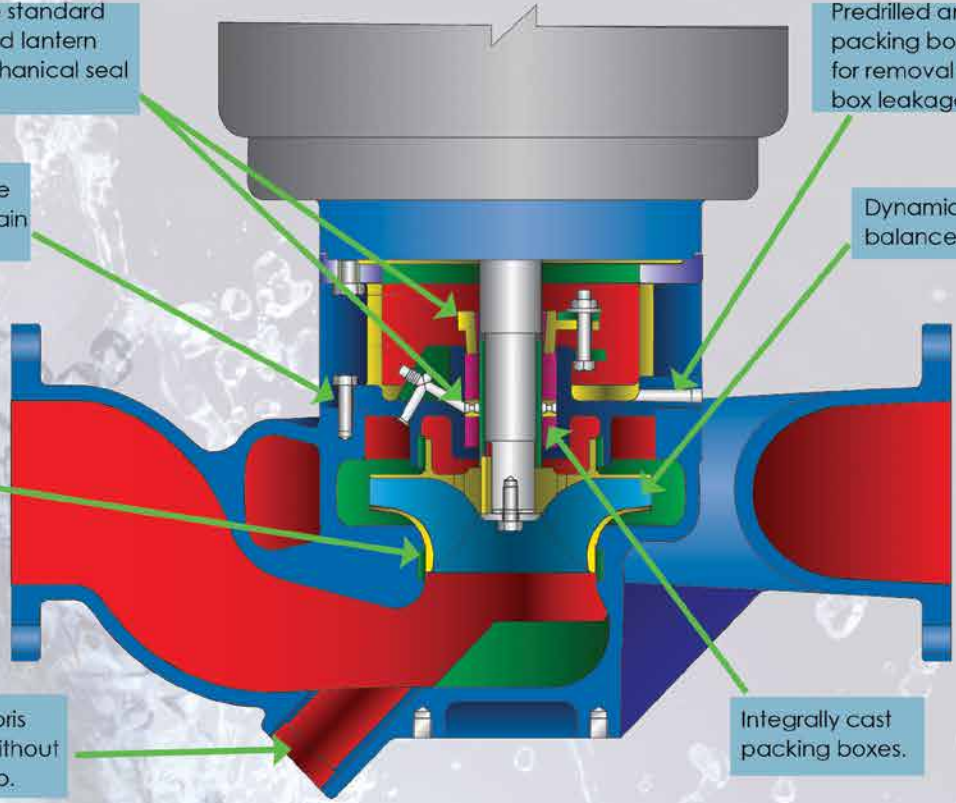

The Pump People®

Axial and Mixed Flow Pumps

Specially designed and built to meet individual customer requirements.

Patterson Type "G" Axial and Mixed Flow Pumps have demonstrated over and over again their ability to move large volumes of liquid at low to medium heads with an efficiency and economy unobtainable with any other type of pump. These pumps consist of: a bowl assembly, which is cast and provides much more reliable service; an outer column and discharge elbow; shaft and shaft cover tube; floor plate; and motor mounting stand.

The axial flow propeller or mixed flow impeller is positioned in its individual impeller housing just above the suction bell and close to the pump inlet. Water enters the pump through the suction bell, is discharged by the impeller into a guide vane section or diffuser, and then is pumped through the outer column to the discharge connection of the pump elbow. The pumps may be built in one or more stages, depending on the total head requirements, in bowl sizes from 12 in. to 84 in. Capacities run from 2,000 gpm to 500,000 gpm, with heads up to 60 ft per stage. Custom units are available if your requirements exceed the above conditions.

Axial and Mixed Flow Pumps can be furnished with an open line shaft when pumping a relatively clear product. Patterson can also provide "pull out" designs to make regularly scheduled inspection and maintenance easier. The design permits removal of the entire bowl assembly, including all rotating parts, diffuser, impeller housing and suction bell, through the outer shell without disturbing either discharge or floor plate connections.

These pumps generally operate in a submerged state with suction entrances flooded. Horizontal units are installed with a positive suction head.

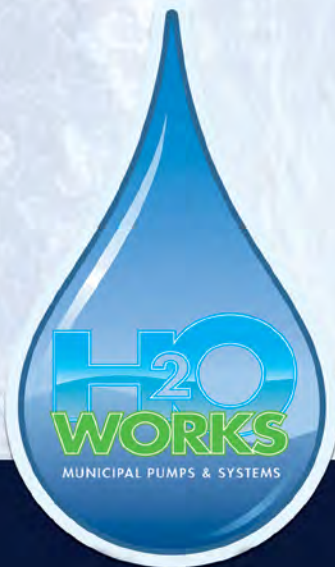
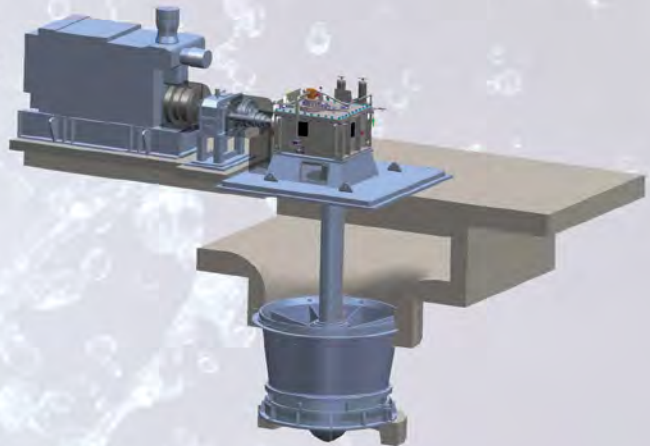

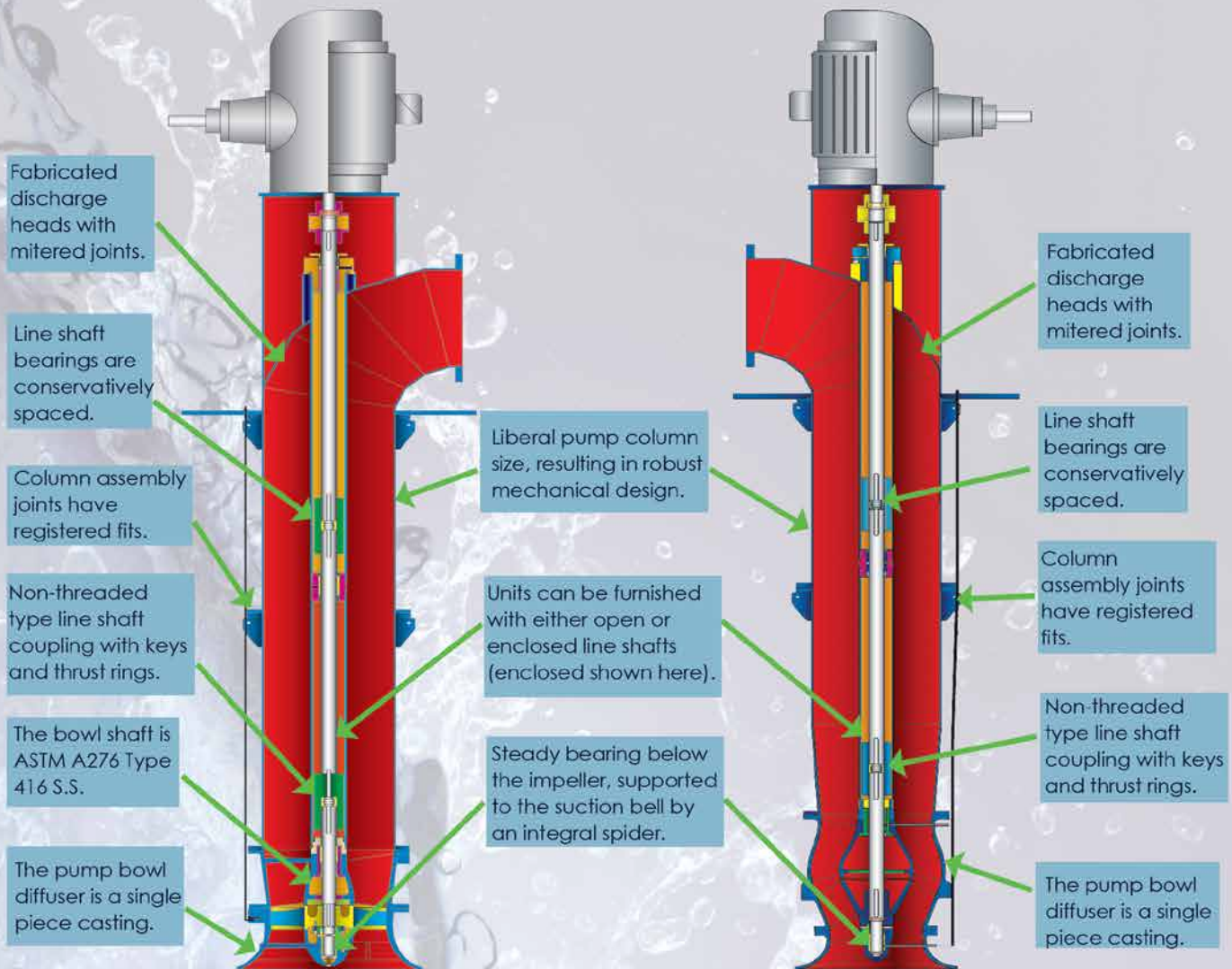

Available in open or enclosed line shaft configurations. Enclosing tubes, when used, are schedule 80 and are supported by spiders when required by the pump length.



Patterson PVT Pumps

The latest design concepts and engineering technology for highly efficient pumping.

Patterson Vertical Turbine (PVT) Pumps are among the most versatile in the company product line. They were designed by Patterson with more than 50 years of vertical pump experience behind them.

These pumps employ the latest design concepts and engineering technology in producing highly efficient pumps that are adaptable in a variety of industrial, municipal and power applications, including fire pumps. They can be staged as necessary to meet desired pressure requirements. Minimum floor space is required, and the pumps operate in low NPSHA applications.

Patterson currently offers 12 in. through 40 in. bowls, providing the capability to handle flows in excess of 30,000 gpm.

Standard construction offers cast iron discharge heads from 6 in. to 14 in., with fabricated steel column, stainless steel head and bowl shafts, alloy steel line shaft and cast iron bronze fitted bowls. Open line shaft construction is standard.

Special construction requiring stainless steel or aluminum bronze is available, and fabricated steel heads in lieu of cast iron are available in both above and below grade discharge configurations.

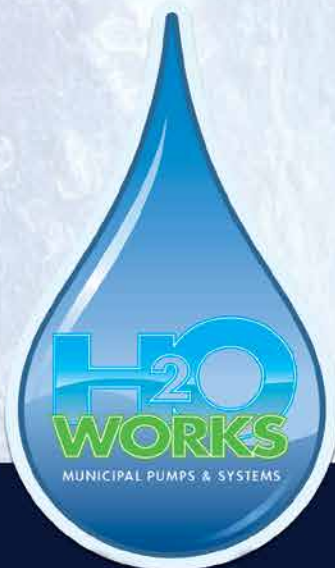

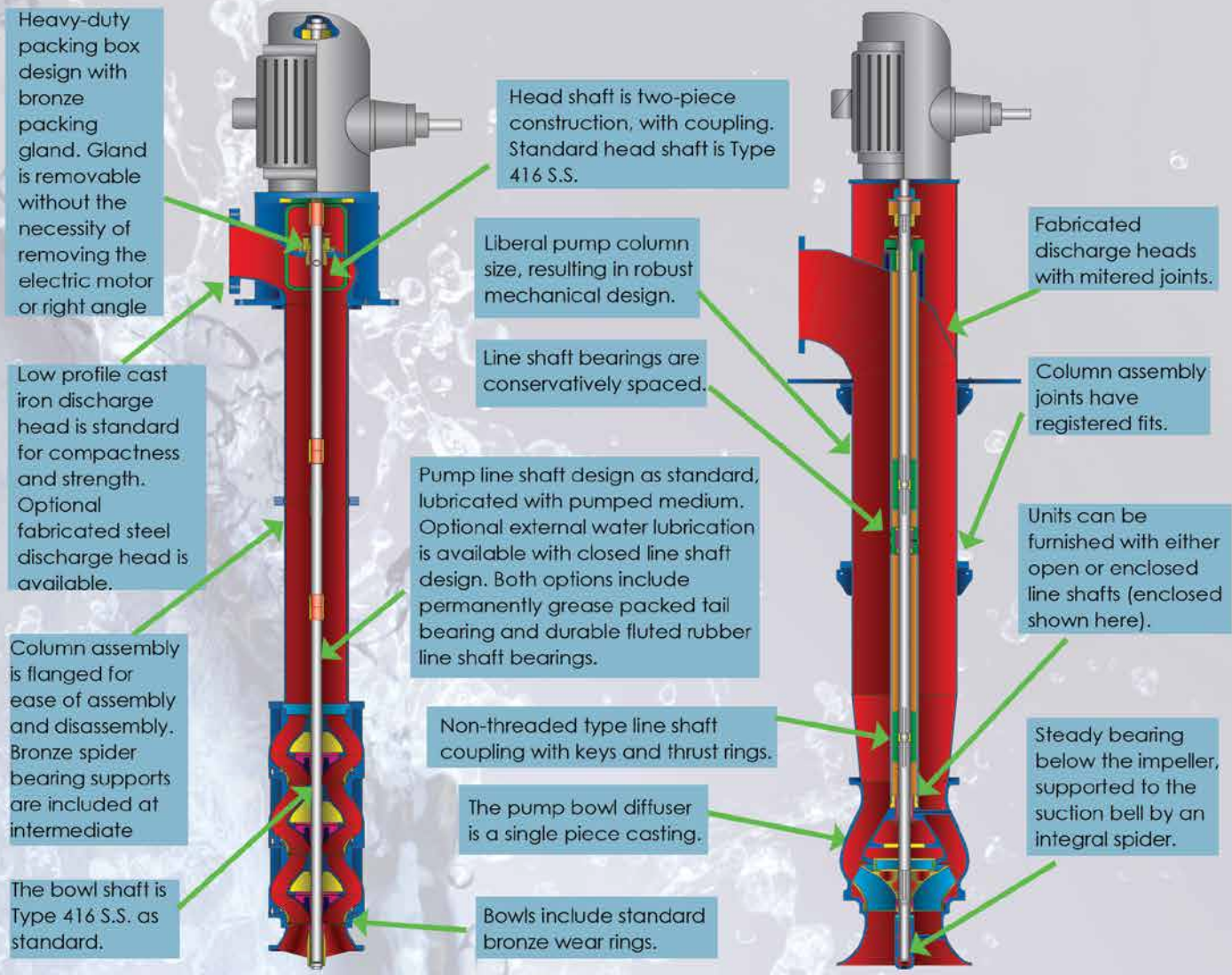

The Pump People®

Delivering Confidence, Performance and Integrity

Get what you need, when you need it...
with Patterson.

Comprehensive Test Laboratory.

With enormous capacity and flexibility, Patterson's advanced Hydraulic Test Facility delivers a new dimension of confidence.

One of the industry's largest and most comprehensive test laboratories, Patterson's modern test facility offers a complete closed-loop system under ideal research conditions.

This fully instrumented test laboratory—built around a 400,000 gal below-grade reservoir and a 100,000 gal aboveground storage tank—is capable of verifying every design and performance specification of Patterson pumps, including cavitation testing and model testing.

Patterson requires a large pump hydraulic testing area because a significant number of sizable and very diverse custom pumps are manufactured for worldwide customers. These include horizontal split case, non-clog, vertical in-line and large pumps, such as axial/mixed flow and turbine-type pumps.

The test facility is not only large, but it also features a comprehensive range of testing equipment to ensure both mechanical and hydraulic performance. With this enormous capacity, pumps can be tested for a wide variety of simulated field conditions. Then, from the assembled test data, it is an easy matter for computers to generate values of pump capacity, head, horsepower and efficiency.

Proven Quality and Reliability for More Than a Century. It is Patterson's century-long dedication to the quality, innovation and reliability of its products that has inspired its high-quality, valued employees.

Patterson's design engineers are driven to continuously make incremental improvements throughout the company's product line and to develop leading-edge pumping technology.

Just as Patterson's highly trained machinists meticulously operate the cutting-edge, computer-controlled machining centers, vertical turning centers and computerized lathes—all to create Patterson products with high-precision workmanship in less time for faster delivery.

The quality and reliability of Patterson products doesn't stop at installation. Patterson is equally dedicated to providing the finest field and factory service and maintaining the best service department in the industry.

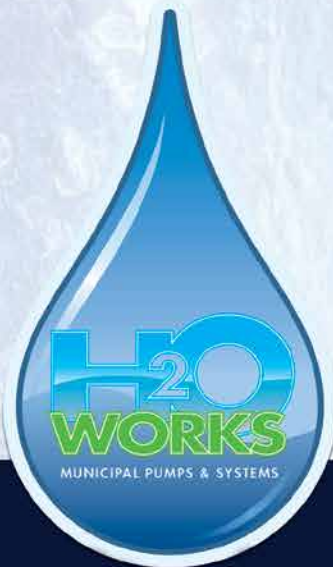

Pumping Technology for Tomorrow's World

Patterson has built a firm reputation of reliable pump installations worldwide—whether satisfying urban water and waste demands; harnessing and controlling ravaging floods; reclaiming arid deserts; taming rampaging and devastating fires; or protecting the planet's ecological balance.

Patterson Pump Company leads America as one of the foremost designers and manufacturers of: Split Case Pumps; Fire Pumps; Axial and Mixed Flow Pumps; Vertical Turbine Pumps; End Suction Pumps; Vertical In-Line Pumps; solids handling pumps; engineered packaged systems.

ISO 9000 Certification. Patterson does more than strive for quality and reliability; Patterson has invested in the company's core values.

Patterson is ISO 9000 certified, attesting to its world-class quality and dependability. The company is continually reevaluated, with a complete reassessment every three years, to ensure all elements are maintained in keeping its products world-class.

Six Sigma. Patterson has also invested into its Six Sigma program. Six Sigma is an optimized level of performance. That's overall excellence—not only in a world-class finished product, but also in the administrative, service and manufacturing processes throughout the company. Patterson's Six Sigma program is a proven methodology that standardizes the right

tools and techniques, while providing working teams with step-wise progressions in applying these tools. The program has successfully enhanced Patterson's reputation for high-quality, reliable pump design, manufacture and service.



The Pump People®



PATTERSON PUMP COMPANY
A Gorman-Rupp Company
Post Office Box 790 • Toccoa, Georgia 30577 – USA
(706) 886-2101
www.pattersonpumps.com
E-mail: marketing@pattersonpumps.com

PATTERSON PUMP IRELAND LTD.
Mullingar, Ireland
E-mail:
rpelot@ie.pattersonpumps.com

PATTERSON PUMP COMPANY/ MIDDLE EAST
Athens, Greece
E-mail: ageorgakis@pattersonpumps.com

PATTERSON PUMP COMPANY/ FAR EAST
Singapore
E-mail: chlow@pattersonpumps.com

PATTERSON MEXICO
Queretaro, Mexico
E-mail: melissa@cosielsaqro.com

PATTERSON LATIN AMERICA
San Jose, Costa Rica
E-mail: rodolfo.zeledon@pattersonpumps-latam.com