

FLEX-PRO A3 & A4

Feed Rates to 158.5 GPH
Pressures to 125 PSI
2500:1 Turndown ratio
Tube Failure Detection
Brushless DC Motor
NEMA 4X (IP 66) Washdown
2 Year Warranty



Model A4

Model A3

NEMA 4X



Exclusive:



Patents: 4,496,295 7,001,153 and other patents pending

Applications:

- Chemical Metering
- Wastewater Treatment
- Chlorination
- Chloramination
- Fluoridation
- Polymer Injection
- Pulp & Paper Slurries
- Printing Inks
- Oil Based Fluids
- Gaseous Fluids
- Shear Sensitive Fluids
- Caustics
- Chemical Slurries
- Food and Beverage

Features:

- Peristaltic pump design does not have valves that can clog requiring maintenance.
- Self priming - even against maximum line pressure. By-pass valves are not required. Cannot vapor lock or lose prime.
- Output rates to: 158.5 GPH (600 LPH) and pressures to 125 PSI (8.6 Bar).
- No maintenance brushless variable speed motor.
- Specially engineered tubing for long life at high pressures. Meets FDA 21 CFR requirements for food contact applications.
- Patented Tube Failure Detection (TFD) system. Senses tube failure by detecting chemical in the pump head. No false triggering.
- 2500:1 turndown ratio.
- SCADA Inputs include: 4-20mA, 0-10Vdc, and Pulse inputs for remote external speed control and 0-30 VDC / contact closure remote start/stop.
- Operator friendly digital touch pad with menu driven software.
- VGA Graphic multi-color backlit LCD displays remote/local control status, motor speed, output rate, input signal values, service and alarm status.
- Outputs include: Scalable 4-20mA or pulse, one 250V/6A relay and three 115V/1A contact closures assignable to monitor up to 17 different pump functions including TFD, FVS, remote/local control setting, motor on, fault, current operating mode, and others.
- Two molded squeeze rollers and two alignment rollers for optimum squeeze, unparalleled accuracy, and tube life.
- Heavy duty rotor - single piece plastic rotor means no flexing and increased accuracy with no metal springs or hinges to corrode.
- Inject at maximum pressure in either direction (clockwise and counter clockwise).
- Patent pending feature to extended tube life.
- Compatible with Blue-White's output Flow Verification Sensor (FVS) system.

Engineering Specifications:

Maximum working pressure (excluding pump tubes):

125 psig (8.6 bar)

Note: see individual pump tube assembly maximum pressure ratings.

Maximum Fluid temperature (excluding pump tubes):

185° F (85° C)

Note: see individual pump tube assembly maximum temperature ratings.

Ambient Operating Temperature

14°F to 115°F (-10°C to 46°C)

Ambient Storage Temperature

-40°F to 158°F (-40°C to 70°C)

Operating Voltage:

A3 MODELS: 96 to 264VAC-50/60Hz, 220W

A4 MODELS: 96 to 264VAC-50/60Hz, 350W

Power Cord Options:

115V60Hz = NEMA 5/15 (USA)

230V60Hz = NEMA 6/15 (USA)

220V50Hz = CEE 7/VII (EU)

240V50Hz = AS 3112 (Australia/New Zealand)

Enclosure:

NEMA 4X (IP66), Polyester powder coated aluminum.

Maximum Overall Dimensions:

A3 models: 8-1/8"W x 10-3/4"H x 15-1/4"D (20.6W x 27.3H x 38.9D cm)

A4 models: 12-1/8"W x 14-1/4"H x 18-5/8"D (30.8W x 36.1H x 47.3D cm)

Approximate shipping wt:

A3 models: 33 lb. (15.0 Kg)

A4 models: 58 lb. (26.3 Kg)

Motor speed adjustment range:

2,500:1 (0.04% - 100% motor speed)

Motor speed adjustment resolution:

0.1% increments > 10% motor speed

0.01% increments > 1% motor speed and < 10%

0.001% increments < 1% motor speed

Maximum viscosity:

12,000 Centipoise

Maximum suction lift:

30 ft. Water, 0 psig (9.14 m, 0 bar)

Display

3 color VGA backlit LCD, UV resistant.

Display Resolution

0.1 > 10% motor speed

0.01 > 1% motor speed and < 10%

0.001 < 1% motor speed

Display Languages

English, Spanish, French or German selectable.

Keypad

Ten button positive action tactile switch keypad.

Security

Programmable 4-digit password.

Materials of Construction:

Wetted components:**Pump Tube Assembly (Model Specific - 2 provided):**

Tubing: Flex-A-Prene® or Flex-A-Chem® or Flex-A-Thane®

Adapter fittings: .PVDF

Injection / Back-flow Check valve:

Body & insert: PVDF

Check Ball: Ceramic

Spring: Hastelloy C-276

Ball Seat O-ring: TFE/P (optional EP)

Static Seal O-ring: TFE/P (optional EP)

Ancillary Items provided**For "S" tubing type connections only:**

(Available on A3 only)

Suction Tubing: 3/8" OD x 1/4" ID x 10' Clear PVC

Discharge Tubing: 3/8" OD x 1/4" ID x 10' Polyethylene (LLDPE)

Suction Strainer: PVDF

For "B" barb tubing and "M" M/NPT connections only:

(Available on ND, NKL, NGG, NEE, G2G, and A4 only)

Suction Strainer:

Body: PVDF

Check Ball: Ceramic

Ball Seat O-ring: TFE/P (optional EP)

For "C" Tri-clamp and "Q" Quick Disconnect connections* only:

(Available on ND, NKL, NGG, NEE, and G2G only)

Suction Strainer: PVDF

*Quick Disconnect Valves sold separately

Non-Wetted components:**Enclosure:**

413 Aluminum (Polyester powder coated)

Pump Head:

Valox® (PBT) thermoplastic

Pump Head Cover:

Polycarbonate for added strength and chemical resistance.

Permanently lubricated sealed motor shaft support ball bearing.

Cover Screws:

Stainless Steel

Roller Assembly:

Rotor:Valox® (PBT)

Rollers:PVDF/Nylon

Roller Bearings:SS Ball Bearings

Motor Shaft:

Chrome plated steel

TFD System Sensor pins:

Hastelloy C-276

Power Cord:

3 conductor, SJTW-A Water-resistant

Tube Installation Tool:

GF Nylon

Mounting Brackets and Hardware:

316 Stainless Steel

Output Specifications:

Feed Rate		Max Speed	Max Pressure	Max Temperature	A3 Model Numbers				
Flex-A-Prene® A3 Tube Pumps									
Meets FDA criteria for food Excellent chemical resistance CIP SIP									
GPH	LPH	ML/Min	RPM	PSI (bar)	F (C)	115V AC	230V AC	220V AC	
.001 - 2.10	.003 - 7.8	.05 - 132	125	125 (8.6)	185 (85)	A3V24-*ND	A3V25-*ND	A3V26-*ND	
.010 - 25.3	.038 - 96.0	.6 - 1596	125	125 (8.6)	185 (85)	A3V24-*NJ	A3V25-*NJ	A3V26-*NJ	
.013 - 33.3	.050 - 126	.8 - 2100	125	125 (8.6)	185 (85)	A3V24-*NK	A3V25-*NK	A3V26-*NK	
.013 - 33.3	.050 - 126	.8 - 2100	125	30 (2.1)	185 (85)	A3V24-*NKL	A3V25-*NKL	A3V26-*NKL	
Flex-A-Prene® A3 Tube Pumps									
Meets FDA criteria for food Excellent chemical resistance Extra long tube life									
GPH	LPH	ML/MIN	RPM	PSI (bar)	F (C)	115V AC	230V AC	220V AC	
.002 - 4.76	.007 - 18.0	.12 - 300	125	110 (7.6)	185 (85)	A3V24-*NEE	A3V25-*NEE	A3V26-*NEE	
.007 - 19.02	.03 - 72.0	.48 - 1200	125	110 (7.6)	185 (85)	A3V24-*NGG	A3V25-*NGG	A3V26-*NGG	
Flex-A-Chem® A3 Tube Pumps									
Meets FDA criteria for food Superior chemical resistance									
GPH	LPH	ML/Min	RPM	PSI (bar)	F (C)	115V AC	230V AC	220V AC	
.006 - 15.06	.022 - 57.0	.4 - 950	125	50 (3.4)	130 (54)	A3V24-*TH	A3V25-*TH	A3V26-*TH	
.014 - 35.19	.053 - 133.2	.9 - 2220	125	50 (3.4)	130 (54)	A3V24-*TK	A3V25-*TK	A3V26-*TK	
Flex-A-Thane® A3 Tube Pumps									
Meets FDA criteria for food Resistant to oils, greases and fuels									
GPH	LPH	ML/Min	RPM	PSI (bar)	F (C)	115V AC	230V AC	220V AC	
.002 - 4.6	.007 - 17.4	.1 - 290	125	65 (4.5)	130 (54)	A3V24-*GE	A3V25-*GE	A3V26-*GE	
.004 - 10.1	.015 - 38.4	.3 - 637	125	65 (4.5)	130 (54)	A3V24-*GG	A3V25-*GG	A3V26-*GG	
.010 - 24.9	.038 - 94.2	.6 - 1570	125	65 (4.5)	130 (54)	A3V24-*GH	A3V25-*GH	A3V26-*GH	
.011 - 28.5	.043 - 108	.7 - 1800	125	65 (4.5)	130 (54)	A3V24-*GK	A3V25-*GK	A3V26-*GK	
.007 - 18.23	.03 - 69.0	.46 - 1150	125	65 (4.5)	130 (54)	A3V24-*G2G	A3V25-*G2G	A3V26-*G2G	
Feed Rate		Max Speed	Max Pressure	Max Temperature	A4 Model Numbers				
Flex-A-Prene® A4 Tube Pumps									
Meets FDA criteria for food Excellent chemical resistance CIP SIP									
GPH	LPH	ML/Min	RPM	PSI (bar)	F (C)	115V AC	230V AC	220V AC	
.01 - 28.5	.04 - 108	.7 - 1800	125	125 (8.6)	185 (85)	A4V24-*NH	A4V25-*NH	A4V26-*NH	
.02 - 44.4	.07 - 168	1.1 - 2800	125	100 (6.9)	185 (85)	A4V24-*NJ	A4V25-*NJ	A4V26-*NJ	
.02 - 50.7	.08 - 192	1.3 - 3200	125	80 (5.5)	185 (85)	A4V24-*NK	A4V25-*NK	A4V26-*NK	
.02 - 54.0	.09 - 204	1.4 - 3400	125	100 (6.9)	185 (85)	A4V24-*NHH	A4V25-*NHH	A4V26-*NHH	
.02 - 54.0	.09 - 204	1.4 - 3400	125	65 (4.5)	185 (85)	A4V24-*NHHL	A4V25-*NHHL	A4V26-*NHHL	
.04 - 100.0	.15 - 378	2.5 - 6300	125	50 (3.4)	185 (85)	A4V24-*NL	A4V25-*NL	A4V26-*NL	
.06 - 158.5	.24 - 600	4.0 - 10000	125	30 (2.1)	185 (85)	A4V24-*NP	A4V25-*NP	A4V26-*NP	
Flex-A-Chem® A4 Tube Pumps									
Meets FDA criteria for food Superior chemical resistance									
GPH	LPH	ML/Min	RPM	PSI (bar)	F (C)	115V AC	230V AC	220V AC	
.02 - 54.00	.08 - 204	1.36 - 3400	125	30 (2.1)	130 (54)	A4V24-*TK	A4V25-*TK	A4V26-*TK	
.05 - 126	.20 - 477	3.2 - 8000	125	30 (2.1)	130 (54)	A4V24-*TKK	A4V25-*TKK	A4V26-*TKK	
Flex-A-Thane® A4 Tube Pumps									
Meets FDA criteria for food Resistant to oils, greases and fuels									
GPH	LPH	ML/Min	RPM	PSI (bar)	F (C)	115V AC	230V AC	220V AC	
.01 - 39.6	.06 - 150	1.0 - 2500	125	65 (4.5)	130 (54)	A4V24-*GH	A4V25-*GH	A4V26-*GH	
.02 - 55.5	.09 - 210	1.4 - 3500	125	65 (4.5)	130 (54)	A4V24-*GK	A4V25-*GK	A4V26-*GK	
.04 - 100	.20 - 378	2.5 - 6300	125	65 (4.5)	130 (54)	A4V24-*GKK	A4V25-*GKK	A4V26-*GKK	

* Inlet/outlet connection types available: **S** = 3/8" OD x 1/4" ID flexible tubing with compression type connections (A3 models only), **M** = 1/2" male NPT **MB** = 1/2" male BSPT **B** = 1/2" ID tubing barb type connections (ND, NKL, NEE, NGG, G2G, and A4 models only), **C** = 3/4" tri-clamp connections (ND, NKL, NEE, NGG, and G2G only), **Q** = Quick Disconnect (ND, NKL, NEE, NGG, and G2G only) (**Valves sold separately**) Note: output volumes based on testing with water at 72 degrees F, 5 foot suction lift, atmospheric conditions at sea level.

Chemical Resistance of Tubing:

Flex-A-Prene® Tubing

Meets FDA criteria for food | Excellent chemical resistance

Alcohol general	Citric Acid 50%	Hydrochloric acid 33%	Potassium hydroxide
Aluminum Sulfate (Alum)	Ethylene glycol	Hydrocyanic acid	Propylene glycol
Ammonium chloride	Ferric chloride	Hydrogen peroxide	Sodium hydroxide 50%
Ammonium hydroxide	Ferric nitrate	Hypochlorous acid	Sodium Bisulfite
Ammonium Sulfate (LAS)	Ferric sulfate	Iodine	Sodium Chlorite 12%
Benzyl alcohol	Ferrous chloride - 43% in water	Magnesium chloride	Sodium Hypochlorite 12.5%
Bleach	Ferrous sulfate	Magnesium sulfate	Sodium sulfide
Brine solutions	Fluosilicic Acid (up to 25%)	Phosphoric acid	Sulfuric acid up to 50%
Calcium Hydroxide 10% (Lime Slurry)	Formic acid	Plating solutions	Tannic acid
Calcium hypochlorite 20%	Glucose	Polyaluminum Chloride (PAC)	

Flex-A-Chem® Tubing - Ultra smooth plasticizer-free bore (inner liner)

Meets FDA criteria for food | Superior chemical resistance

Ferrous Chloride (up to 40%)	Phosphoric Acid (up to 85%)	Bases	Applications:
Fluoboric Acid (up to 48%)	Potassium Hypochlorite (up to 70%)	Salts	Ink and solvent production
Fluosilicic Acid (up to 25%)	Potassium Permanganate (up to 6%)	Ketones	Battery acid filling
Hydrofluoric Acid (up to 48%)	Sodium Phosphate (up to 30%)	Alcohols	Specialty chemical production / processing
Nitric Acid (up to 71%)	Sulfuric Acid (up to 98%)	Isobutyl Alcohol	Sensitive fluid transfer

Flex-A-Thane® Tubing

Meets FDA criteria for food | Resistant to oils, greases and fuels

Cyclohexane	Kerosene	Oils:	Oils:
Diesel Fuel	Lard	ASTM reference No.1,2,3	Linseed
Fatty acids	Mineral spirits	Castor	Lubricating
Gasoline	Soap solutions	Coconut	Mineral
Heptane	Turpentine	Fuel	
Hexane			

Pump Tube Assembly Output Specifications:

Model A3 - Available Pump Tubes and Output Ranges

Tube Material	Tube Size	Max Pressure	Max Temp	Required Roller Part Number	Output Range		
Material	Code	PSI (bar)	F (C)		GPH	LPH	ML/Min
Flex-A-Prene	ND	125 (8.6)	185 (85)	A3-SND-R	.001 - 2.1	.003 - 7.8	.05 - 132
Flex-A-Prene	NEE	110 (7.6)	185 (85)	A3-SNGG-R	.002 - 4.76	.007 - 18.0	.12 - 300
Flex-A-Prene	NGG	110 (7.6)	185 (85)	A3-SNGG-R	.007 - 19.02	.03 - 72.0	.48 - 1200
Flex-A-Prene	NJ	125 (8.6)	185 (85)	A3-SNGG-R	.010 - 25.3	.038 - 96.0	.6 - 1596
Flex-A-Prene	NK	125 (8.6)	185 (85)	A3-SNGG-R	.013 - 33.3	.050 - 126.0	.8 - 2100
Flex-A-Prene	NKL	30 (2.1)	185 (85)	A3-STH-R	.013 - 33.3	.050 - 126.0	.8 - 2100
Flex-A-Chem	TH	50 (3.4)	130 (54)	A3-STH-R	.006 - 15.06	.022 - 57.0	.4 - 950
Flex-A-Chem	TK	50 (3.4)	130 (54)	A3-SNGG-R	.014 - 35.19	.053 - 133.2	.9 - 2220
Flex-A-Thane	GE	65 (4.5)	130 (54)	A3-SGE-R	.002 - 4.60	.007 - 17.4	.1 - 290
Flex-A-Thane	GG	65 (4.5)	130 (54)	A3-SGE-R	.004 - 10.1	.015 - 38.4	.3 - 637
Flex-A-Thane	GH	65 (4.5)	130 (54)	A3-SGE-R	.010 - 24.9	.038 - 94.2	.6 - 1570
Flex-A-Thane	GK	65 (4.5)	130 (54)	A3-SGE-R	.011 - 28.5	.043 - 108.0	.7 - 1800
Flex-A-Thane	G2G	65 (4.5)	130 (54)	A3-SGE-R	.007 - 18.23	.03 - 69.0	.46 - 1150

Model A4 - Available Pump Tubes and Output Ranges

Tube Material	Tube Size	Max Pressure	Max Temp	Required Roller Part Number	Output Range		
Material	Code	PSI (bar)	F (C)		GPH	LPH	ML/Min
Flex-A-Prene	NH	125 (8.6)	185 (85)	A4-MNH-R	.01 - 28.5	.04 - 108	.7 - 1800
Flex-A-Prene	NJ	100 (6.9)	185 (85)	A4-MNH-R	.02 - 44.4	.07 - 168	1.1 - 2800
Flex-A-Prene	NK	80 (5.5)	185 (85)	A4-MNH-R	.02 - 50.7	.08 - 192	1.3 - 3200
Flex-A-Prene	NHH	100 (6.9)	185 (85)	A4-MNH-R	.02 - 54.0	.09 - 204	1.4 - 3400
Flex-A-Prene	NHHL	65 (4.5)	185 (85)	A4-MNH-R	.02 - 54.0	.09 - 204	1.4 - 3400
Flex-A-Prene	NL	50 (3.4)	185 (85)	A4-MNL-R	.04 - 100.0	.15 - 378	2.5 - 6300
Flex-A-Prene	NP	30 (2.1)	185 (85)	A4-MNL-R	.06 - 158.5	.24 - 600	4.0 - 10000
Flex-A-Chem	TK	30 (2.1)	130 (54)	A4-MTH-R	.02 - 54.0	.08 - 204	1.36 - 3400
Flex-A-Chem	GH	65 (4.5)	130 (54)	A4-MGH-R	.01 - 39.6	.06 - 150	1.0 - 2500
Flex-A-Thane	GK	65 (4.5)	130 (54)	A4-MGH-R	.02 - 55.5	.09 - 210	1.4 - 3500
Flex-A-Thane	GKK	65 (4.5)	130 (54)	A4-MGH-R	.04 - 100	.20 - 378	2.5 - 6300

FLEX-PRO® Peristaltic Metering Pump

Engineering and Technical Data

Dimensions:

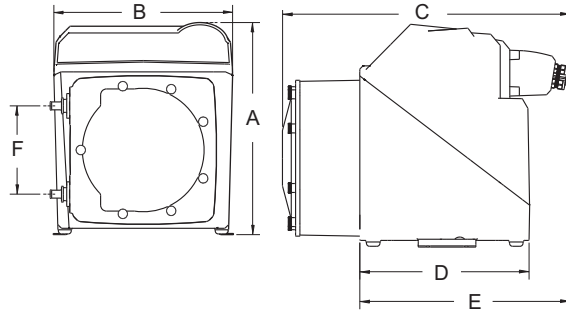

Dim	A3 Series		A4 Series	
	Inches	cm	Inches	cm
A	10-3/4"	27.3	14-1/4"	36.1
B	8-1/8"	20.6	12-1/8"	30.8
C	15-1/4"	38.9	18-5/8"	47.3
D	10"	25.4	11"	27.9
E	12-1/4"	31.0	13-5/8"	34.6
F	4-1/4"	10.7	6"	15.2

Model Number Matrix:

Flex-Pro Model Number							
A3	Flex-Pro A3 Peristaltic Metering Pump						
A4	Flex-Pro A4 Peristaltic Metering Pump						
Series							
F	Single manual output control (manual/local control only)						
V	Multiple automatic input output control and alarm modes (remote control)						
Maximum Motor Speed							
2	125 RPM (maximum rotor rotation speed)						
Power Cord (operating voltage requirement 96VAC to 264VAC)							
4	115V / 60Hz, power cord NEMA 5/15 plug (US)						
5	230V / 60Hz, power cord NEMA 6/15 plug (US)						
6	220V / 50HZ, power cord CEE 7/VII plug (EU)						
8	240V / 50HZ, power cord AS 3112 plug (Australia/New Zealand)						
9	230V / 50HZ, power cord BS 1363 plug (UK)						
X	No Power Cord						
Inlet/Outlet Connection Size, Connection Type, Connection Material							
S	3/8" OD x 1/4" ID Tube Compression Fitting, Natural PVDF (Kynar), available for A3 models only						
M	1/2" Male NPT Fitting, Natural PVDF (Kynar), available for A3 and A4 models						
B	1/2" ID Tubing Barb Fitting, Natural PVDF (Kynar), available for ND, NK, NKL, NEE, NGG, G2G, and A4 models only						
C	1/2" - 3/4" Tri-clamp connections, Natural PVDF (Kynar), available for ND, NK, NKL, NEE, NGG, and G2G only						
Q	Quick Disconnect, Natural PVDF (Kynar), available for ND, NKL, NEE, NGG, and G2G only (Valves sold separately), available for A3 models only						
M	1/2" Male BSPT Fitting, Natural PVDF (Kynar), available for A3 and A4 models						
Pump Tube Material, Pump Tube Size							
ND	Flex-A-Prene® .075 ID - A3 models only						
NH	Flex-A-Prene® .250 ID - A4 models only						
NHL	Flex-A-Prene® .250 ID (65 PSI max pressure)- A4 models only						
NHH	Flex-A-Prene® .250 ID (Dual Tube) - A4 models only						
NJ	Flex-A-Prene® .312 ID						
NK	Flex-A-Prene® .375 ID						
NKL	Flex-A-Prene® .375 ID (30 PSI max pressure - longer life)						
NL	Flex-A-Prene® .500 ID - A4 models only						
NP	Flex-A-Prene® .750 ID - A4 models only						
TH	Flex-A-Chem® .250 ID						
NHHL	Flex-A-Prene® .250 ID (Dual Tube)(65 PSI max pressure)						
TK	Flex-A-Chem® .375 ID						
TKK	Flex-A-Chem® .375 ID (Dual Tube) - A4 models only						
GE	Flex-A-Thane® .125 ID - A3 models only						
GG	Flex-A-Thane® .187 ID - A3 models only						
GH	Flex-A-Thane® .312 ID						
GHH	Flex-A-Thane® .312 ID (Dual Tube) - A4 models only						
GK	Flex-A-Thane® .375 ID						
GKK	Flex-A-Thane® .375 ID (Dual Tube) - A4 models only						
NEE	Flex-A-Prene® .093 ID (Dual Tube) - A3 models only						
NGG	Flex-A-Prene® .187 ID (Dual Tube) - A3 models only						
G2G	Flex-A-Thane® .187 ID (Dual Tube) - A3 models only						
Options (leave this blank for standard model with left facing head)							
1	T140-6V Threadless injection check valve, replaces A-014NK-6A threaded check valve						
2	C340A Foot valve, replaces standard C-342 inlet strainer (no check valve)						
R	Right facing pump head, input / output (Left facing fluid input / output is standard)						
D	Down facing pump head, input / output (Left facing fluid input / output is standard)						
E	EP O-Rings						
A3	V	2	4	-	S	NH	Sample Model Number

FLEX-PRO® Peristaltic Metering Pump

Engineering and Technical Data







Features list:

Feature
TFD (Tube Failure Detection) System Alarm
FVS (Flow Verification System) Alarm *
Motor reverse (rotor reversible)
Three position pump head rotation
Tube life timer
Output: One, 6 amp alarm relay
Output: Three, dry contact or maximum 30VDC/115VAC 1 amp contact closures
Output: Programmable 4-20mA signal or high speed pulse, proportional to pump output
Input: One, contact closure (remote start / stop)
Input: Remote speed control via 4-20mA, 0-10VDC, high speed digital pulse, contact closure pulse
Remote/Local control settings
Password protection
Display: Motor speed, Tube Failure Detection (TFD) system and Flow Verification System (FVS) alarm status
Display: Output in ml/min, oz/min, L/hr, Gal/hr, Gal/day, RPM, and input signal values
Automated PPM chemical dosing system
Available Operating Modes:
Manual (local): speed adjustment
Remote input: 4-20mA
Remote input: 0-10 VDC
Remote input: high speed frequency (pulse) input
Remote input: pulse triggered batch dispensing
Remote input: proportional PPM (parts per million) dosing with high speed frequency (pulse) input
Manual (local): batch dispensing
Manual (local): repeating cycle timer
Manual (local): fixed speed PPM (parts per million) dosing

* Requires Micro-Flo Sensor sold separately

Quick-Disconnect Valve Kits (Sold Separately)

For use with the Quick-Disconnect Flex-A-Prene Tube Assembly

3/8" OD, 1/4" Tubing		1/2" Hose Barb		1/2" M/NPT	
					
Part #	O-ring	Part #	O-ring	Part #	O-ring
KIT-QSV	FKM	KIT-QBV	FKM	KIT-QMV	FKM
KIT-QSE	EP	KIT-QBE	EP	KIT-QME	EP

Note: Quick-Disconnect valves are only available for A2 and A3 model pumps.

