

TYPE 37FS/37FSB

SPLIT SEAL

Installation, Operation & Maintenance Instructions



SPLIT SEAL

Installation, Operation & Maintenance Instructions

Introduction

Split seals represent a solution for converting packed stuffing boxes to mechanical seals. Seal installation requires careful attention when the split seal faces are assembled. Perfect mating of the two halves must be assured, especially when the seal faces are made of

fine grain materials. The two halves can easily slide with respect to each other ending into a potential step at the sealing interface, and therefore a *potential* leakage path, or face chipping.

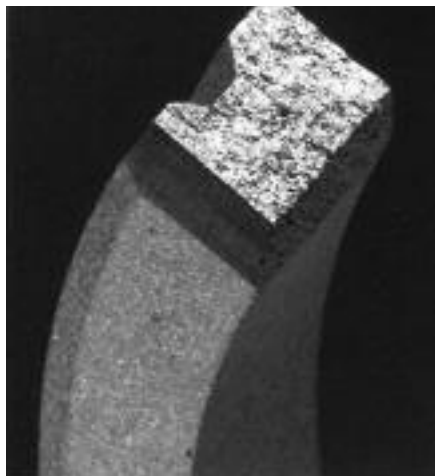

Coarse grain Silicon
Carbide split joints



Fine grain Silicon
Carbide split joints

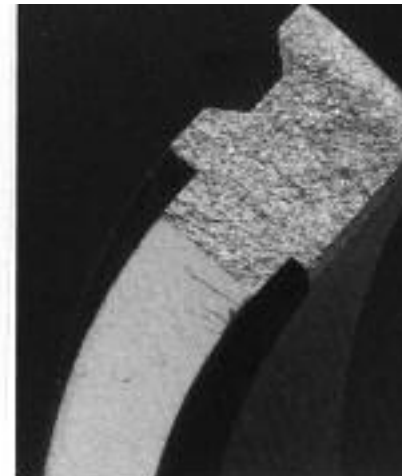

Carbon split joints

SPLIT SEAL

Installation, Operation & Maintenance Instructions

Typical Type 37FS Seal Arrangement

General Instructions

1. Be sure to read all instructions carefully before installing seal to prevent the potential mismatch of the two sealing halves. Consult the general arrangement drawing and applicable notes included with the actual seal.
2. The John Crane Type 37FS seal is a precision product. To assure satisfactory operation, handle seal with care. Take particular caution to see that the lapped sealing faces are not scratched or marred.
3. Absolutely no grease or lubricant is to be used on the shaft during installation.

**Installation Kit:

Allen wrenches
Silicone grease
RTV sealant
Adhesive
Alcohol prep pad
Screwdriver
Centering gauge

Part Name

1. Mating Ring	8. Cap Screw
2. Compression Ring	9. Set Screw
3. Mating Ring	10. Cap Screw
4. Sealing Ring	11. Gland Plate Assembly
5. Drive Ring Assembly	12. Cap Screw*
6. Clamp Ring	13. Compression Tool
7. Cap Screw	14. Cap Screw
*Not illustrated	15. Installation Kit**

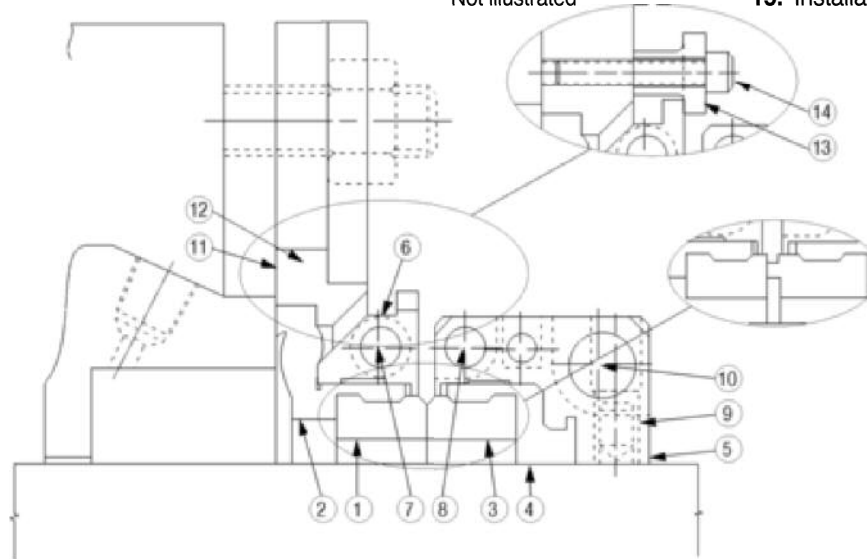

Part 3 becomes the primary ring when made of carbon.

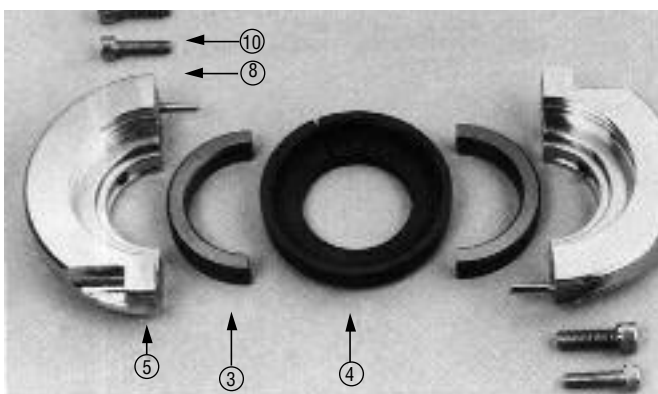
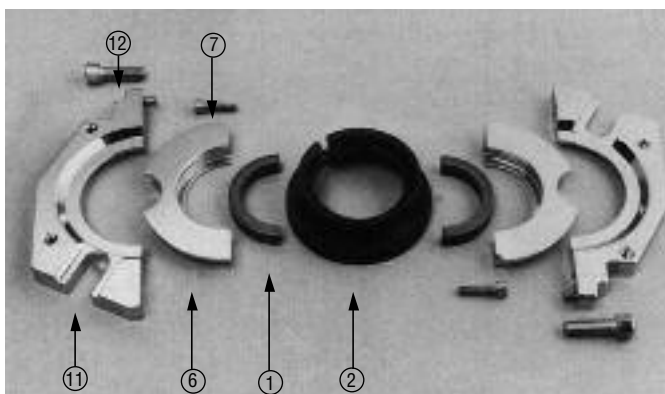

NOTE: For non-standard seals (adaptors, special gland, bushings, etc.) see attached appendixes.

SPLIT SEAL

Installation, Operation & Maintenance Instructions

Preparing the Equipment

1. Check seal chamber dimensions and finishes.

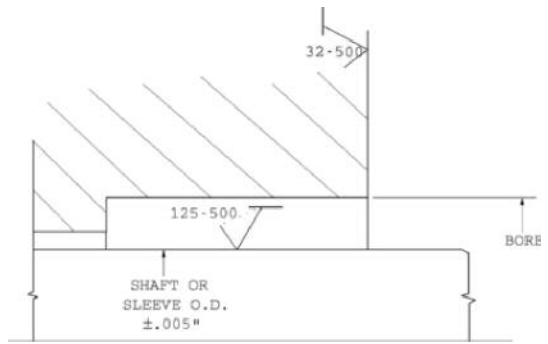

2. Maximum axial end play
 Seal sizes 1.375" to 2.937" -0.020" T.I.R. max
 Seal sizes 3.000" to 10.000" -0.060" T.I.R. max.

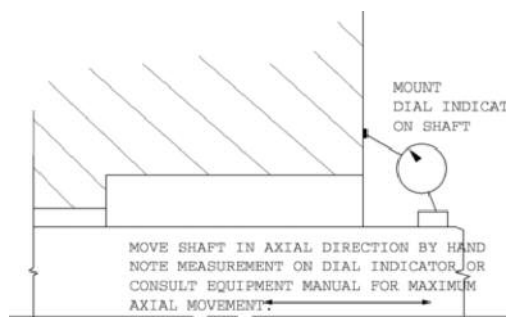

3. Determine squareness of seal chamber face to shaft
 Carbon vs. Silicon = 0.050" T.I.R. max
 Silicon vs. Silicon = 0.100" T.I.R. max

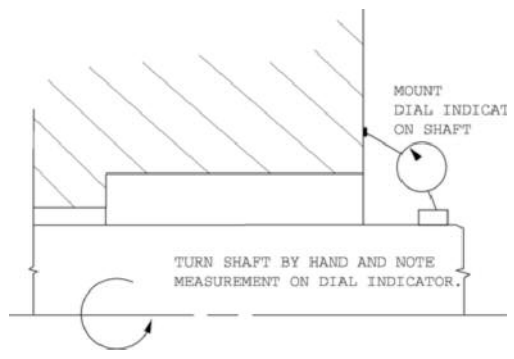

4. Measure shaft runout
 (0.020" T.I.R. max).

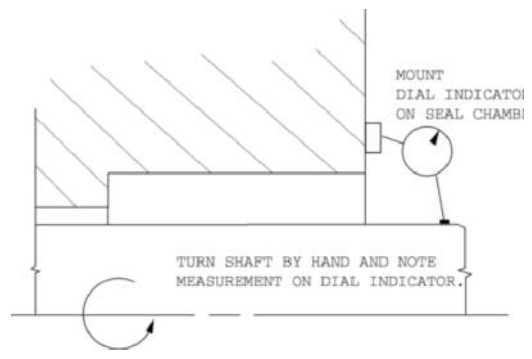

5. Check stuffing box face waviness
 (0.030" T.I.R. max).

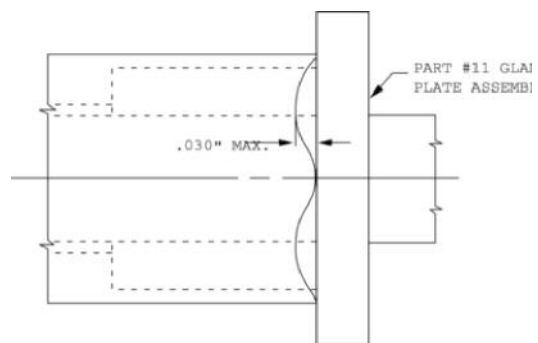

6. Maximum radial shaft movement
 (0.124" T.I.R. max)

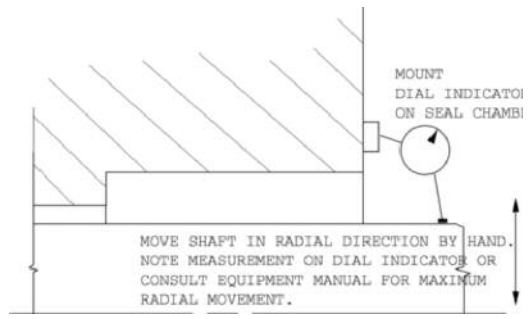

SPLIT SEAL

Installation, Operation & Maintenance Instructions

Type 37FS Seal Installation Dimensions

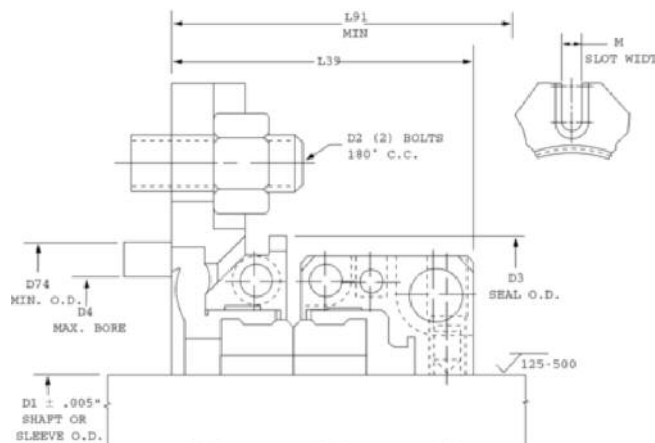

Shaft/Sleeve

L39

SIZE	D2	D3	D4	D74	M	SIC/SIC*	CAR/SIC**	L91
D1								
1.375	3.750 - 5.000	3.642	2.406	3.000	.562	1.968	2.000	2.500
1.500	3.875 - 5.125	3.767	2.531	3.125	.562	1.968	2.000	2.500
1.625	4.000 - 5.250	3.892	2.656	3.250	.562	1.968	2.000	2.500
1.687	4.062 - 5.312	3.955	2.718	3.312	.562	1.968	2.000	2.500
1.750	4.125 - 5.375	4.017	2.781	3.375	.562	1.968	2.000	2.500
1.875	4.250 - 5.500	4.142	2.906	3.500	.562	1.968	2.000	2.500
1.937	4.312 - 5.562	4.205	2.968	3.562	.562	1.968	2.000	2.500
2.000	4.375 - 5.625	4.268	3.031	3.625	.562	1.968	2.000	2.500
2.125	4.500 - 5.750	4.393	3.156	3.750	.562	1.968	2.000	2.500
2.250	4.625 - 5.875	4.518	3.281	3.875	.562	1.968	2.000	2.500
2.375	4.750 - 6.000	4.643	3.406	4.000	.562	1.968	2.000	2.500
2.437	4.812 - 6.062	4.705	3.468	4.062	.562	1.968	2.000	2.500
2.500	4.875 - 6.125	4.768	3.351	4.125	.562	1.968	2.000	2.500
2.625	5.000 - 6.250	4.893	3.656	4.250	.562	1.968	2.000	2.500
2.750	5.125 - 6.375	5.018	3.781	4.375	.562	1.968	2.000	2.500
2.937	5.312 - 6.562	5.205	3.968	4.562	.562	1.968	2.000	2.500
3.000 - 3.250	6.500 - 8.500	5.450	4.812	5.375	.562	2.600	2.665	3.000
3.250 - 3.437	6.750 - 8.750	5.700	5.062	5.625	.562	2.600	2.665	3.000
3.437 - 3.812	7.625 - 10.125	6.137	5.500	6.062	.687	2.600	2.665	3.000
3.812 - 4.187	8.000 - 10.500	6.512	5.875	6.437	.687	2.600	2.665	3.000
4.187 - 4.562	8.375 - 10.875	6.887	6.250	6.812	.687	2.600	2.665	3.000
4.562 - 4.937	8.750 - 11.250	7.262	6.625	7.187	.687	2.600	2.665	3.000
4.937 - 5.312	9.125 - 11.625	7.637	7.000	7.562	.687	2.600	2.665	3.000
5.312 - 5.687	10.000 - 12.500	8.012	7.375	7.937	.812	2.600	2.665	3.000
5.687 - 6.062	10.375 - 12.875	8.387	7.750	8.312	.812	2.600	2.665	3.000
6.062 - 6.437	10.750 - 13.250	8.762	8.125	8.687	.812	2.600	2.665	3.000
6.437 - 6.812	11.125 - 13.625	9.137	8.500	9.062	.812	2.600	2.665	3.000
6.812 - 7.187	11.500 - 14.000	9.512	8.875	9.437	.812	2.600	2.665	3.000
7.187 - 7.562	11.625 - 14.625	10.137	9.250	9.812	.812	2.710	2.770	3.125
7.562 - 7.937	12.000 - 15.000	10.512	9.625	10.187	.812	2.710	2.770	3.125
7.937 - 8.312	12.375 - 15.375	10.887	10.000	10.562	.812	2.710	2.770	3.125
8.312 - 8.687	12.750 - 15.750	11.262	10.375	10.937	.812	2.710	2.770	3.125
8.687 - 9.062	13.500 - 16.500	12.762	11.875	11.312	.812	2.710	2.770	3.125
9.062 - 9.437	13.875 - 16.875	12.012	11.125	11.687	.812	2.710	2.770	3.125
9.437 - 9.812	14.250 - 17.250	12.387	11.500	12.062	.812	2.710	2.770	3.125
9.812 - 10.187	14.625 - 17.625	12.762	11.875	12.437	.812	2.710	2.770	3.125

* SIC/SIC = Silicon Carbide vs. Silicon Carbide

** CAR/SIC = Carbon vs. Silicon Carbide

SPLIT SEAL

Installation, Operation & Maintenance Instructions

Type 37FSB Seal Installation Dimensions

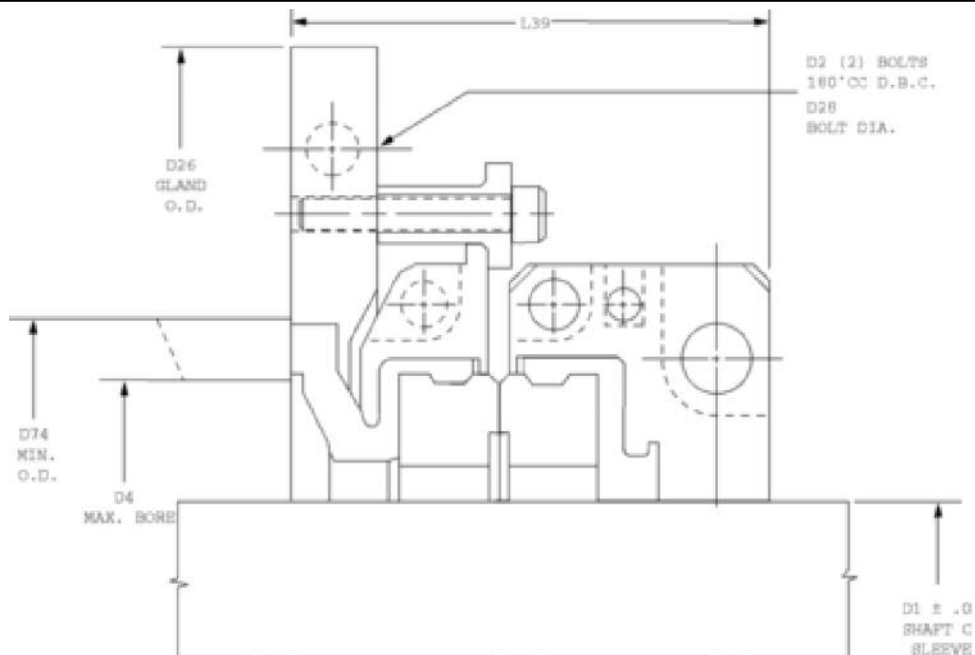

Shaft/Sleeve							L39	
SIZE								
D1	D2	D4	D26	D28	D74	SIC/SIC*	CAR/SIC**	
3.437 - 3.811	8.250 - 10.750	5.375	11.750	.750	6.182	3.42	3.48	
3.812 - 4.186	8.625 - 11.125	5.750	12.125	.750	6.557	3.42	3.48	
4.187 - 4.561	9.000 - 11.500	6.125	12.500	.750	6.932	3.42	3.48	
4.562 - 4.936	9.375 - 11.875	6.500	12.875	.750	7.307	3.42	3.48	
4.937 - 5.311	9.750 - 12.250	6.875	13.250	.750	7.682	3.42	3.48	
5.312 - 5.686	10.125 - 12.625	7.250	13.625	.750	8.057	3.42	3.48	
5.687 - 6.061	10.500 - 13.000	7.625	14.000	.750	8.432	3.42	3.48	
6.062 - 6.436	10.875 - 13.375	8.000	14.375	1.000	8.807	3.63	3.69	
6.437 - 6.811	11.250 - 13.750	8.375	14.750	1.000	9.182	3.63	3.69	
6.812 - 7.186	11.625 - 14.125	8.750	15.125	1.000	9.557	3.63	3.69	
7.187 - 7.568	12.000 - 14.500	9.125	15.500	1.000	9.932	3.63	3.69	
7.569 - 7.936	12.375 - 14.875	9.500	15.875	1.000	10.307	3.63	3.69	
7.937 - 8.311	12.750 - 15.250	9.875	16.250	1.000	10.682	3.63	3.69	
8.312 - 8.685	13.125 - 15.625	10.250	16.625	1.000	11.057	3.63	3.69	
8.686 - 9.061	13.500 - 16.000	10.625	17.000	1.000	11.432	3.63	3.69	
9.062 - 9.436	13.875 - 16.375	11.000	17.375	1.000	11.807	3.63	3.69	
9.437 - 9.811	14.250 - 16.750	11.375	17.750	1.000	12.182	3.63	3.69	
9.812 - 10.187	14.625 - 17.125	11.750	18.125	1.000	12.557	3.63	3.69	

* SIC/SIC = Silicon Carbide vs. Silicon Carbide

** CAR/SIC = Carbon vs. Silicon Carbide

SPLIT SEAL

Installation, Operation & Maintenance Instructions

Installing the Stationary Portion of the Seal

If your layout does not match arrangement on page 3, consult appropriate appendix in the back of instruction manual for step 1.



1. Place gland plate halves around shaft, ensuring beveled ID faces away from the stuffing box. Bolt halves securely together.

2. Apply a thin coat of adhesive to one split end of the compression ring. Place split end around shaft with the larger diameter end facing the stuffing box. Hold ends together until adhesive bonds the ends. Split must match up identically to ensure a proper seal.

3. Fit compression ring into the ID at the back end of the gland plate. Align bonded split in the compression ring at the 11 o'clock position (approximately 1/2" from the top end (12 o'clock position) of the gland plate).

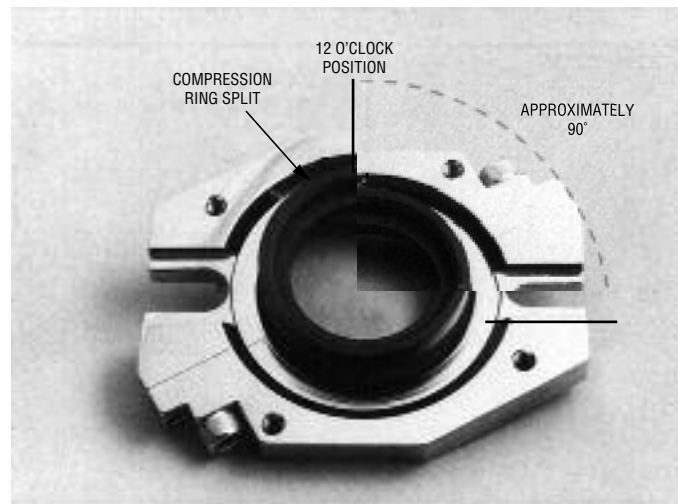

Note: To determine 12 o'clock position on a:
 2 Bolt Gland - 12 o'clock position = 90 degrees from each stud/bolt.
 4 Bolt Gland - 12 o'clock position = 45 degrees from each stud/bolt. (equally spaced studs/bolts)

SPLIT SEAL

Installation, Operation & Maintenance Instructions



4. Slide gland plate assembly containing compression ring over mounting studs. Tighten nuts a few threads to eliminate gland plate from sliding.



5A. Place one half of mating ring into the ID of the compression ring ensuring lapped and beveled edge faces away from the stuffing box. Splits should be at 90 degrees from the 12 o'clock position (i.e. 3 o'clock and 9 o'clock positions). See Figure A.

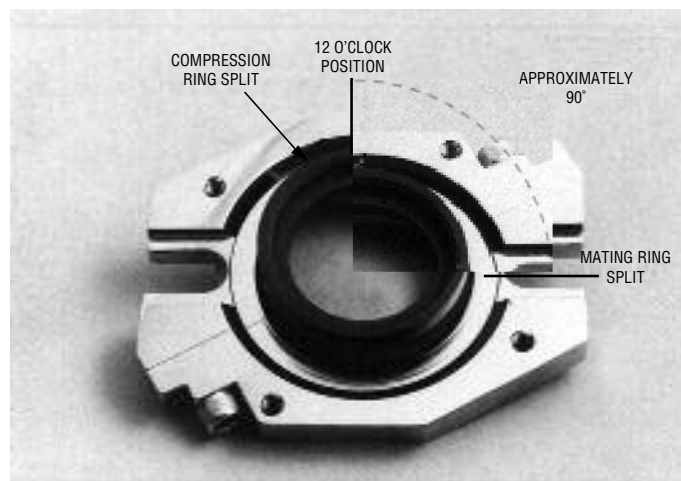

Figure A



5B. Place other half of mating ring in the compression ring making sure split ends of halves DO NOT come in contact with each other while sliding into compression ring. This can be achieved by pushing up the rubber at the 12 o'clock position using curved end of the mating ring, allowing splits to clear matching half.
CAUTION: To minimize the potential for seal failure, care must be taken not to chip the split ends of the mating rings.

SPLIT SEAL

Installation, Operation & Maintenance Instructions



6. Take clamp ring halves and lightly lubricate ID with silicone grease, starting from ID of split joints continuing around ID approximately 1/2" on either side.

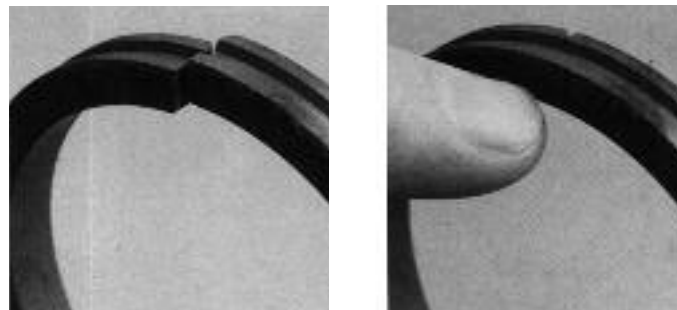

7. Make sure the sealing surfaces of the mating ring halves are flush with one another both axially and radially. Visually and by using your fingernail, determine if there is a step at the joints. Carefully adjust the two halves as needed. See Figure B.

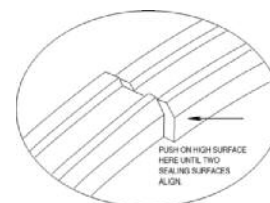
**Figure B**

8. When mating ring halves are flush axially and radially, hold the compression ring at the 12 o'clock and 6 o'clock positions to ensure mating ring splits remain locked into place. Place one half of the clamp ring around the compression ring, with the splits at the 12 o'clock and 6 o'clock positions. Place the other half around and bring the two halves together loosely, tightening cap screws a few threads. The splits of the mating ring and clamp ring should be 90 degrees apart. If access to clamp ring cap screws is limited, the whole stationary assembly can be removed and/or disassembled from the mounting studs and rotated to provide needed access. Caution is required to ensure that the mating ring does not "bump" the shaft.
9. Repeat step 7 to verify that mating ring splits are flush axially and radially.

SPLIT SEAL

Installation, Operation & Maintenance Instructions



10. Proceed tightening the clamp ring halves together evenly, by tightening the screws until clamp ring halves come together firmly. Check frequently that the two mating ring halves remain flush. Adjust as needed.



11. Spread a thin film of RTV sealant on the stuffing box face where it will come in contact with the compression ring. If the surface where compression ring contacts the stuffing box is unknown, apply the RTV sealant to the compression ring.

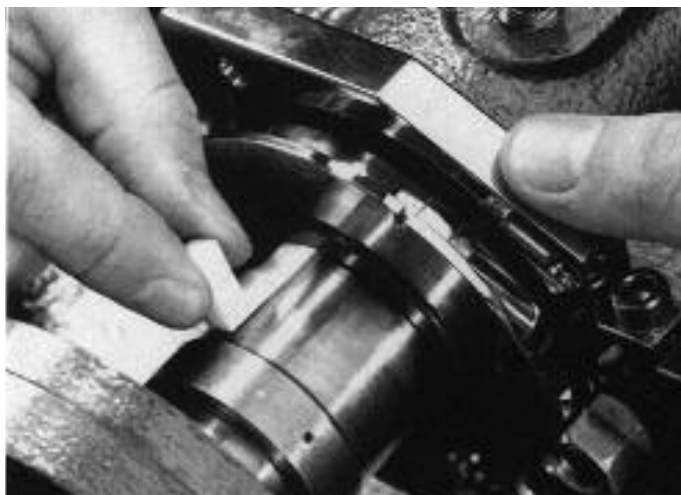

12. Take the seal assembly and push it along mounting studs to the stuffing box face. Tighten nuts evenly on the studs ensuring an even gap between the shaft and mating ring ID. Gap should be checked visually and measured to verify seal is "centered" to the shaft. A centering tool is provided to achieve this. The tool should be placed between the shaft and the mating ring ID to determine that the gap is even. Check at several points around the shaft. After assembly is completely aligned, fully tighten gland plate to stuffing box.



13. Loosely bolt compression tools to the gland plate. The small diameter of the compression tool must face the gland plate. Make sure compression tool grabs outside diameter (OD) of clamp ring. Tighten compression tool screws evenly until all four tools contact the gland plate.

Compression Tool Color Coding
 1.375" - 2.937" 37FS = RED
 3.000" - 7.187" 37FS = BLACK
 7.188" - 10.187" 37FS = YELLOW
 3.437" - 10.187" 37FSB = WHITE

SPLIT SEAL

Installation, Operation & Maintenance Instructions

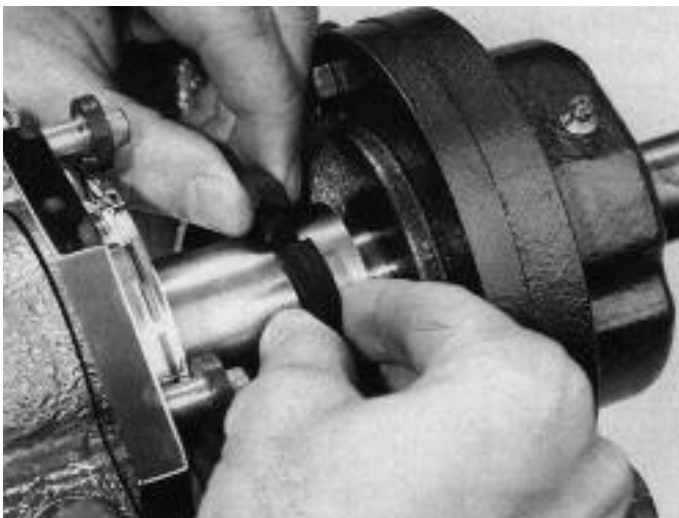

- 14.** Apply a thin coat of adhesive to split end of sealing ring. Place sealing ring around shaft with small ID facing away from the stuffing box. Hold split ends together until the adhesive bonds the ends. Position the sealing ring split at the 11 o'clock position. See Figure C.

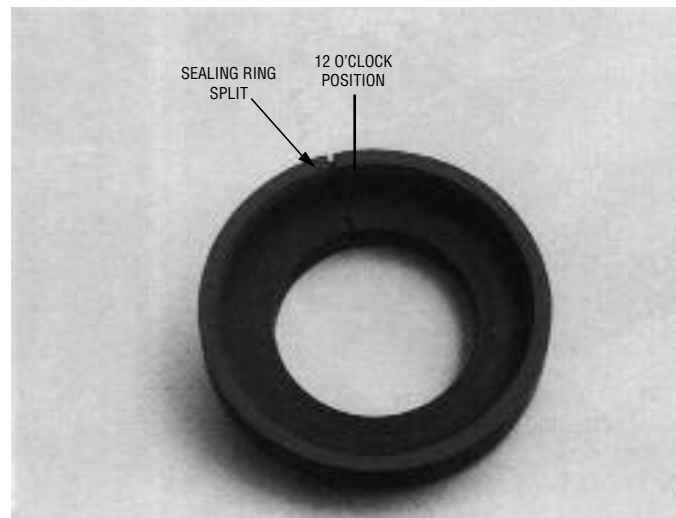
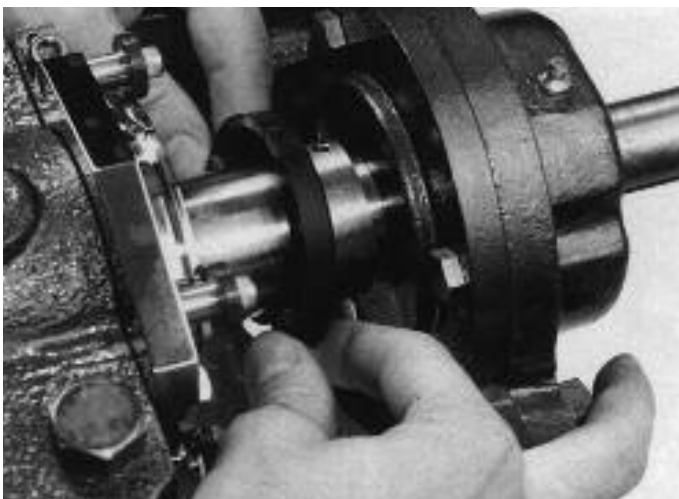
**Figure C**

- 15A.** Place one half of mating ring into the ID of the sealing ring ensuring that the lapped and beveled edge faces the stuffing box. Splits should be 90 degrees from the 12 o'clock position (i.e. 3 o'clock and 9 o'clock position). See Figure D.

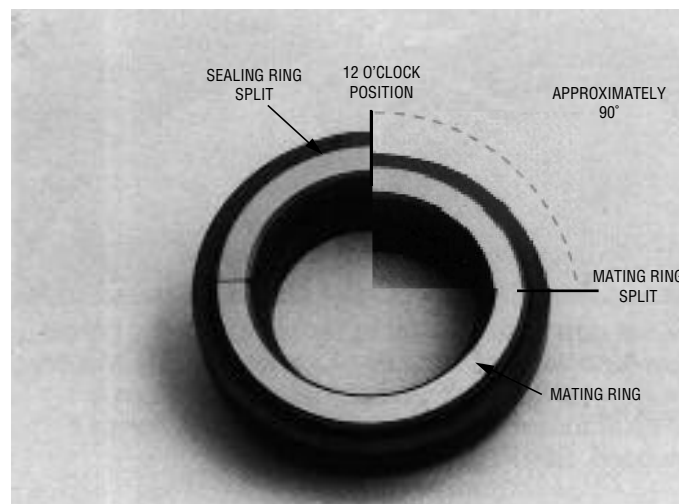
**Figure D**

SPLIT SEAL

Installation, Operation & Maintenance Instructions

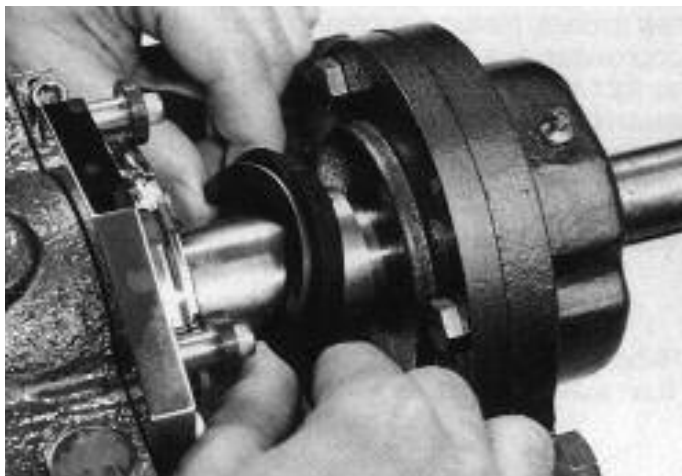

15B. Place other half of mating ring in the sealing ring making sure split ends of halves DO NOT come in contact with each other. This can be achieved by pushing up the rubber at the 12 o'clock position with the curved end of mating ring to allow splits to clear matching half.

CAUTION: To minimize the potential for seal failure, care must be taken not to chip the split ends of the mating rings.

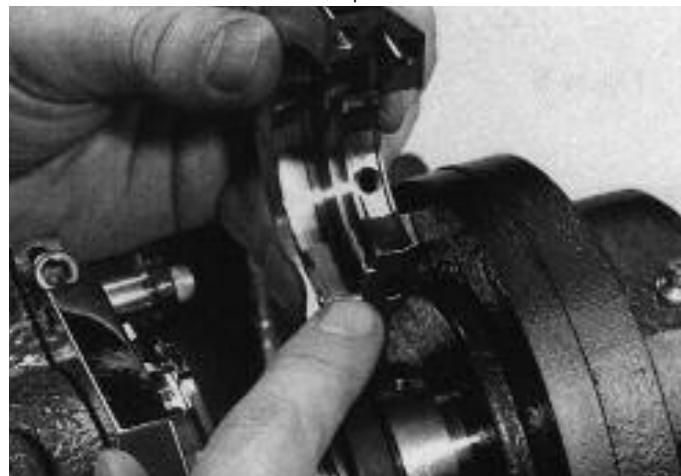

16. Take drive ring halves and lightly lubricate ID with silicone grease, starting from ID of split joints continuing around ID approximately 1/2" on either side.



17. Make sure sealing surfaces of the mating ring halves are flush with one another axially and radially. Visually and by using your fingernail, determine if there is a step at the joints. Carefully adjust the two halves if needed. See Figure E.

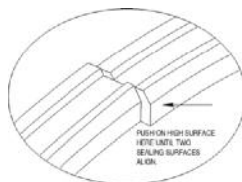

Figure E



18. When mating ring halves are flush both axially and radially, hold the sealing ring at the 12 o'clock and 6 o'clock positions to ensure mating ring splits are locked into place. Place one half of the drive ring around sealing ring, with the drive ring splits at the 12 o'clock and 6 o'clock positions. Place the other half of the drive ring around and bring the two halves together loosely, tightening cap screws a few threads. Resume tightening evenly until there is approximately a 1/4" gap between the halves, or as tight as possible still allowing the drive ring assembly to slide forward. Check frequently that the two mating ring halves remain flush both axially and radially.

Note: The splits of the mating ring and the drive ring should be 90 degrees apart.

SPLIT SEAL

Installation, Operation & Maintenance Instructions

19. Repeat step 17 to verify that mating ring splits are flush axially and radially.



20. Wipe sealing faces clean with alcohol prep pad.

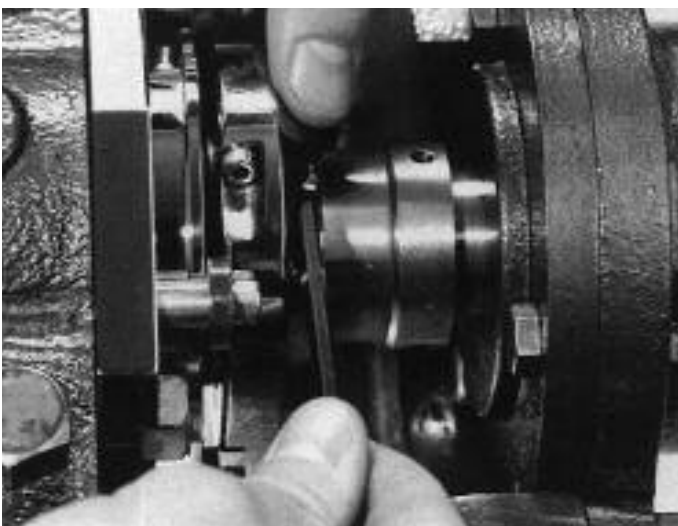

22. Fully tighten bolts (evenly) on drive ring. An engineered gap will remain at the drive ring splits after bolts are fully tightened. See Figure F.
Note: Gap should only exist after bolts are fully tightened. DO NOT loosen bolts to achieve this gap.

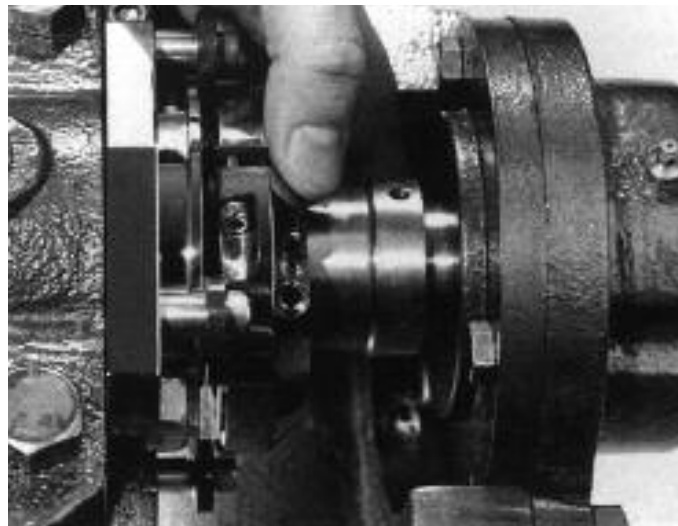

21. Slide drive ring, sealing ring and mating ring assembly toward the stuffing box until mating rings contact. When pushing the assembly forward, push only from the splits to ensure assembly remains even.
Note: Shine a light behind the mating rings at their point of contact verifying their contact. If light is visible between the faces, slide assembly forward.

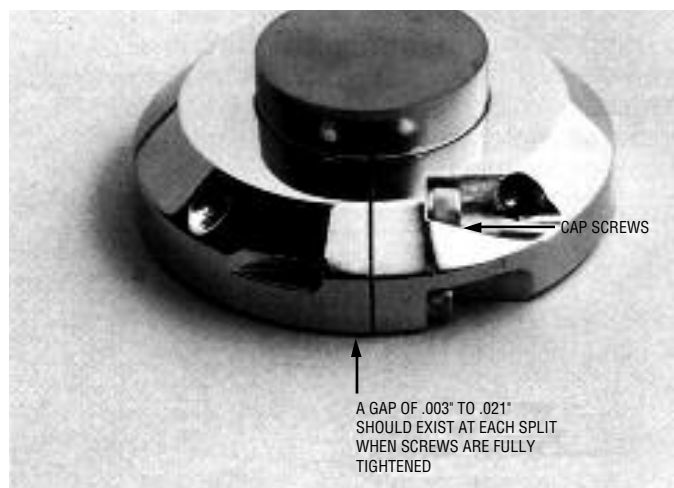
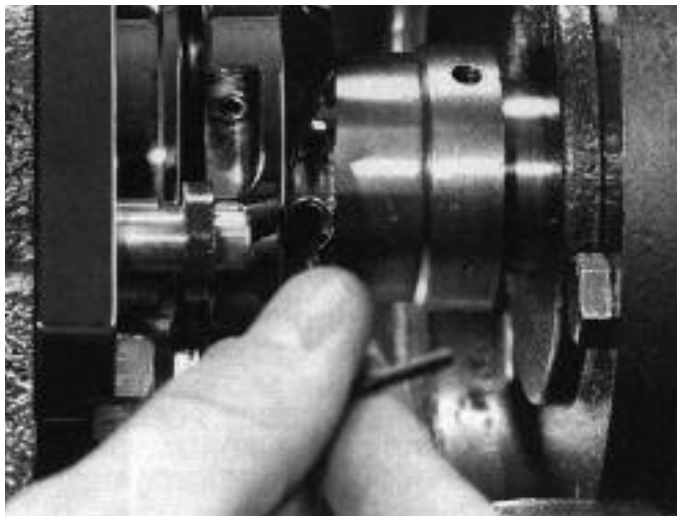

Figure F

SPLIT SEAL

Installation, Operation & Maintenance Instructions



23. Fully tighten set screws on the drive ring to the shaft.

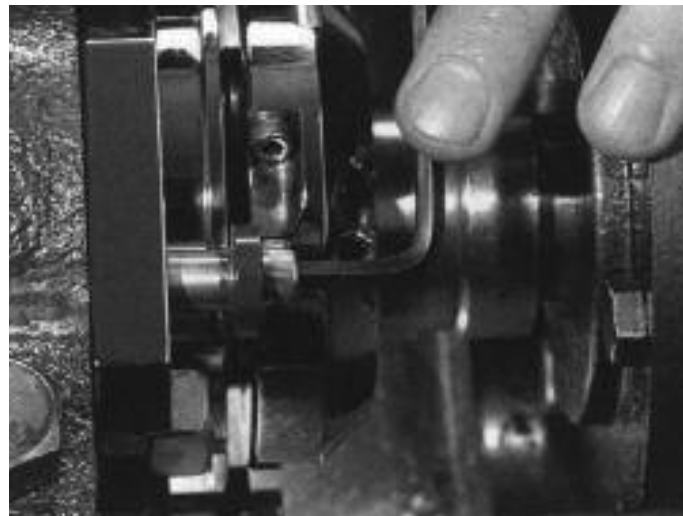

24. Remove the compression tools.

25. Connect proper piping to flush connections of the seal or existing connections in the stuffing box, to ensure seal receives required flush.

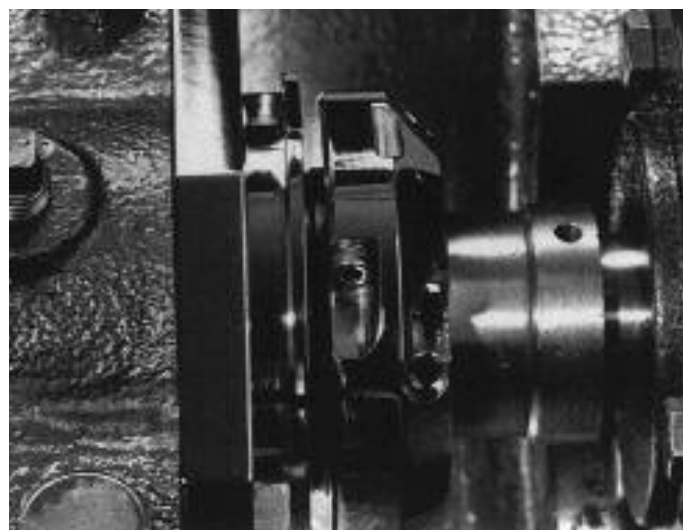

Complete assembled seal.

SPLIT SEAL

Installation, Operation & Maintenance Instructions

Before Starting Unit

1. Check to make certain that the circulation lines are open and free of any obstruction which might interfere with circulation of cooling liquid for the seal.
2. Refer to seal installation drawing or pump manufacturer's instructions for proper piping connections.
3. Ensure before start-up that all personnel and assembly equipment have been removed to a safe distance and that there is no contact with rotating parts on the pump, seal coupling or motor.

WARNING: SEAL INSTALLATION SHOULD BE HANDLED ONLY BY QUALIFIED PERSONNEL. IF QUESTIONS ARISE, CONTACT THE LOCAL JOHN CRANE REPRESENTATIVE. IMPROPER USE AND/OR INSTALLATION OF THIS PRODUCT COULD RESULT IN INJURY TO THE PERSON AND/OR HARMFUL EMISSIONS TO THE ENVIRONMENT, AND MAY EFFECT ANY WARRANTY ON THE PRODUCT. PLEASE CONTACT THE COMPANY FOR INFORMATION AS TO EXCLUSIVE PRODUCT WARRANTY AND LIMITATIONS OF LIABILITY.

Vertical Installations Only

Prior to start-up on vertical installations, proper seal venting is critical, as air and vapors may be entrapped within the seal cavity. To ensure proper seal flushing, process fluid must be pressurized prior to shaft rotation.

Venting Seal Cavity:

1. Place one compression tool on the gland plate. Make sure the compression tool grabs OD of clamp ring.
2. Screw down compression tool until a small gap results between the mating ring surfaces. This will allow trapped air and/or vapors to be vented.
3. When process liquid escapes through the gap, seal cavity is properly vented.
4. Remove compression tool before starting unit.

APPENDIX #1

Special Adaptor Plate with O-Ring

Consult layout supplied with the seal for any variations.

1. Apply a thin coat of RTV sealant to the split ends of adaptor plate. Place adaptor halves around shaft, with the O-ring groove facing the stuffing box. Bolt halves tightly together.
2. Apply a thin coat of adhesive to split end of O-ring. Place O-ring around shaft between the stuffing box and adaptor. Hold ends together until bonded.
3. Slide O-ring into groove in back end of adaptor plate.
4. Spread RTV sealant on the O-ring and groove.
5. Tightly bolt adaptor (evenly) to the stuffing box face leaving an even gap between the adaptor ID and the shaft.
6. Proceed with step #1 of the Standard Installation Manual. Adaptor now acts as the stuffing box face.

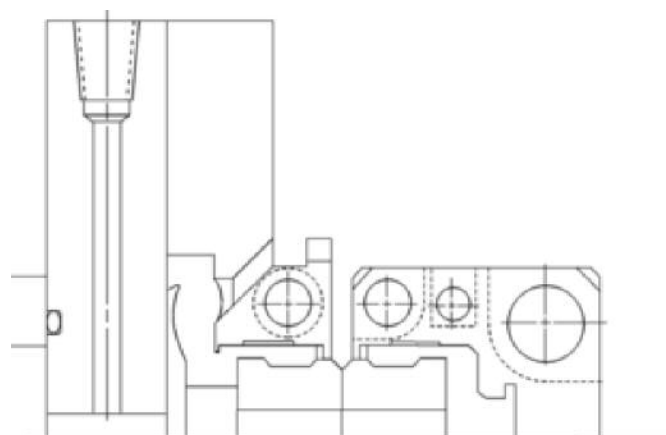

SPLIT SEAL

Installation, Operation & Maintenance Instructions

APPENDIX #2**Special Gland Plate with Clamp Plate**

Consult layout supplied with the seal for any variations.

1. Apply a thin coat of RTV sealant to split surfaces of gland plate. Place gland plate halves around shaft, with the O-ring groove facing the stuffing box. Bolt halves tightly together.
2. Apply a thin coat of adhesive to split end of O-ring. Place O-ring around shaft between the stuffing box and gland plate. Hold ends together until bonded.
3. Slide O-ring into groove in back end of gland plate.
4. Spread RTV sealant on the O-ring and groove.
5. Tightly bolt adaptor (evenly) to the stuffing box face.
6. Apply a thin coat of adhesive to the split end of the compression ring. Place split end around shaft. Gland should be between the stuffing box and the compression ring. Hold ends until bonded. Splits must match up identically to ensure a proper seal.
7. Slide compression ring into groove on the ID of the gland plate. Align bonded split of compression ring to the 11 o'clock position (i.e. 1/2") from the top end (12 o'clock position) of the gland plate.

Note: To determine 12 o'clock position on a:

2 Bolt Gland - 12 o'clock position = 90 degrees from each stud/bolt

4 Bolt Gland - 12 o'clock position = 45 degrees from each stud/bolt
(equally spaced studs/bolts)

8. Tightly bolt the clamp plate to the gland plate assembly.
6. Steps 1-8 on this page eliminate steps 1-4 in the standard installation manual. Proceed with step #5 of standard installation manual.

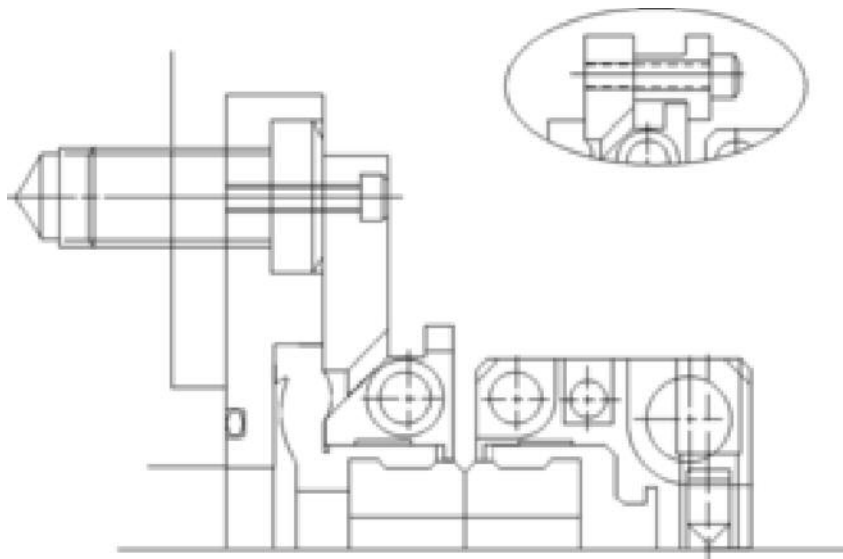

SPLIT SEAL

Installation, Operation & Maintenance Instructions

APPENDIX #3

Special Adaptor & Teflon™ Bushing

Consult layout supplied with the seal for any variations.

1. Place the Teflon bushing around the shaft with the large ID toward the stuffing box face.
2. Apply adhesive to the split end of O-ring and bond it around the shaft.
3. Apply a thin coat of RTV sealant to the split ends of the adaptor plate. Place adaptor around the shaft with the O-ring groove toward the stuffing box face. The recess in the adaptor ID slides around the bushing OD. Tightly bolt adaptor halves together.
4. Slide O-ring into adaptor groove.
5. Apply RTV sealant on the O-ring and groove.
6. Tightly bolt the adaptor to the stuffing box face, leaving an even gap between bushing ID and shaft.
7. Proceed with step #1 of the standard installation manual. Adaptor now acts as the stuffing box face.

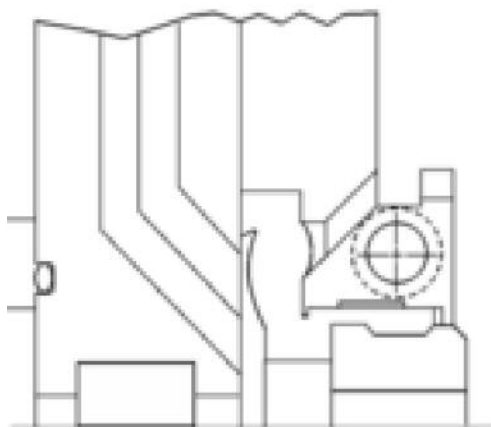

Horizontal Installation

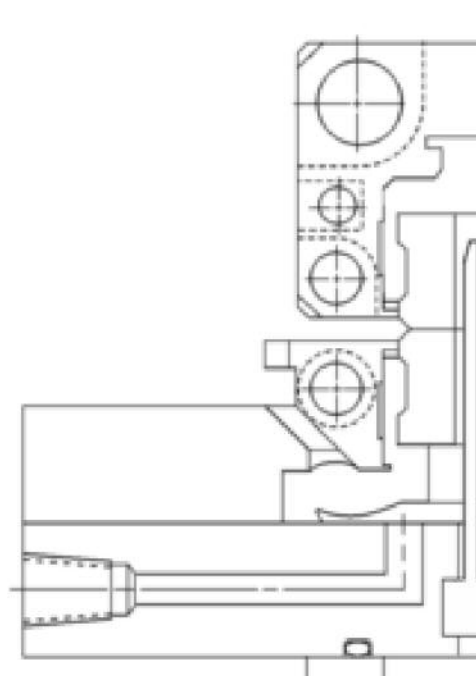

Vertical Installation

SPLIT SEAL

Installation, Operation & Maintenance Instructions

Spare Parts Kit Installation**1. SEAL DISASSEMBLY:**

Seal disassembly is reverse in process, when compared with seal installation. While disassembling the seal, care must be taken not to drop the split seal faces. Some materials, such as Silicon Carbide, are easily chipped and must be handled with care. After a long time in operation, all elastomers have the tendency to “stick” to metal components. Use the screwdriver provided in the installation kit to pry the metal component halves apart.

2. CLEAN AND INSPECT ALL PARTS:

Thoroughly clean and inspect all parts after disassembly. The shaft and stuffing box face should be cleaned and inspected as well.

3. REASSEMBLY:

Proceed with step #1 of the standard installation guide using the cleaned and inspected parts and new mating rings and elastomeric components.

Materials of Construction

Primary Ring*	Carbon
Mating Ring	Silicon Carbide
Hardware	316 Stainless Steel
Elastomers	Ethylene Propylene Buna-N Fluoroelastomer Aflas®

Operating Limits**Type 37FS**

Pressure: 80 psig / 5.5 bar g
Temperature: 180°F / 82°C
Speed: To 1800 rpm

Type 37FSB

Pressure: 200 psig / 14 bar g
Temperature: 180°F / 82°C
Speed: To 1800 rpm

* When hard faces are used, primary ring becomes a mating ring.

Type 37 Ordering Information

Customer's Name: _____

Location: _____

JC Salesman: _____ Phone # _____

1. EQUIPMENT:

Type _____

Manufacturer: _____

Model: _____

Installation: _____ Horizontal _____ Vertical _____

If Vertical: _____ Top Entering _____ Bottom Entering _____

2. APPLICATION:

Process Fluid: _____

Specific Gravity: _____

Viscosity: _____

Vapor Pressure: _____

Injection Fluid: _____

Specific Gravity: _____

Viscosity: _____

Available Pressure: _____

Max. Allowable Pressure: _____

Max. Allowable Flow Rate: _____

3. OPERATION:

Speed: _____

Temperature: _____

Stuffing Box Pressure: _____

Suction Pressure: _____

Discharge Pressure: _____

4. DIMENSIONS:

Sleeve OD (A) (if applicable): _____

Sleeve Extension (B) (if applicable): _____

Shaft/Sleeve Surface Finish: _____

Shaft OD (C): _____

Stuffing Box Bore (D): _____

Stuffing Box OD (E): _____

Bolt Circle Diameter (F): _____

Number & Size of Bolts (G,H): _____

Type of Bolts: (Circle Appropriate)

Swing Bolts, Studs (Removable: Yes__ No__), or Tapped Holes

Bolt Extension (I): _____

Nearest Obstruction (J): _____

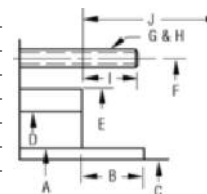

SPLIT SEAL

Installation, Operation & Maintenance Instructions

Teflon is a registered trademark of DuPont
 Aflas is a registered trademark of Asahi Glass Co., Ltd.



North America	Europe	Latin America	Middle East & Africa	Asia Pacific
United States of America	United Kingdom	Brazil	United Arab Emirates	Singapore
Tel: 1-847-967-2400	Tel: 44-1753-224000	Tel: 55-11-3371-2500	Tel: 971-481-27800	Tel: 65-6518-1800
Fax: 1-847-967-3915	Fax: 44-1753-224224	Fax: 55-11-3371-2599	Fax: 971-488-62830	Fax: 65-6518-1803

If the products featured will be used in a potentially dangerous and/or hazardous process, your John Crane representative should be consulted prior to their selection and use. In the interest of continuous development, John Crane Companies reserve the right to alter designs and specifications without prior notice. It is dangerous to smoke while handling products made from PTFE. Old and new PTFE products must not be incinerated. ISO 9001 and ISO14001 Certified, details available on request.